



CORVUS

USER GUIDE Rev - 1.1

Organizational and Intermediate Operation and Intermediate Maintenance Instructions

P/N C-9235-400



COPYRIGHT STATEMENT. DragoonITCN gives the US Government the unlimited right to use, calibrate, repair, and train the CORVUS TEST TOOL and data provided for its intended purpose.

Distribution B: Distribution authorized to U.S. Government Agencies (Critical Technologies).



This memorandum conveys Government Purpose Rights as pertaining to the CORVUS TEST TOOL; Part Numbers C-9235-300, C-9235-400, and C-9235-500 manufactured by DragoonITCN CAGE 1NEY5 in Dayton, OH.

DragoonITCN gives the US Government the unlimited right to use, calibrate, repair, and train the CORVUS TEST TOOL and data provided for its intended purpose.

The data provided shall not be used for procurement or reverse engineering. DragoonITCN restricts the release of the CORVUS data for commercial purposes.

Sincerely,

A handwritten signature in black ink, appearing to read "Robert Appenzeller", written in a cursive style.

Robert Appenzeller, CEO DragoonITCN



Table of Contents

CHAPTER 1 INTRODUCTION.....	1
1. INTRODUCTION	1
1.1. CORVUS OVERVIEW	1
1.2. SAFETY & SECURITY	2
1.3. OPERATION OVERVIEW	2
1.4. Startup Procedure	2
1.5. Shutdown Procedure	3
1.6. Main Menu	3
CHAPTER 2 ACCESSORIES.....	5
2. ACCESSORIES	5
2.1. D-CORVUS.....	5
2.2. Vegas	5
2.3. Battery Pack	6
2.4. Travel Case.....	6
CHAPTER 3 CONFIGURATION EDITOR	7
3. Configuration Editor.....	7
3.1. Configuration Editor Overview.....	7
3.2. Creating a Database	7
3.3. Loading and Editing a Database.....	9
CHAPTER 4 BUS MONITOR.....	10
4. Bus Monitor	10
4.1. 1553 Bus Monitor Overview	10
4.2. Starting A Bus Monitor Session.....	11
4.3. Interpreting Bus Monitor Data	13
4.4. Filtering 1553 Data.....	15
4.5. Custom Layout.....	15
4.6. Exporting 1553 Data.....	17
CHAPTER 5 VECTOR NETWORK ANALYZER	18
5. Vector Network Analyzer.....	18
5.1. Vector Network Analyzer Overview	18



5.2.	Software Setup	19
5.3.	Creating a Database	21
5.4.	Editing a Database	23
5.5.	Pass/Fail Parameters	25
5.6.	Saving a VNA Trace	27
5.7.	Loading a VNA Trace	28
5.8.	Insertion Loss	29
5.9.	Return Loss & Standing Wave Ratio	30
5.10.	Distance To Fault	32
CHAPTER 6 WIREMAP.....		33
6.	<i>Wiremap</i>	33
6.1.	Wiremap Test Overview	33
6.2.	Performing a Wiremap Test	34
6.3.	Interpreting Wiremap Results	35
6.4.	Wiremap Interface Cable Construction.....	36
CHAPTER 7 D-CORVUS.....		37
7.	<i>D-CORVUS</i>	37
7.1.	D-CORVUS Overview	37
7.2.	Aircraft Bus Testing	38
7.3.	Aircraft Stub Connection	38
7.4.	Calibration	40
7.5.	Aircraft Test Setup.....	43
7.6.	D-CORVUS Operation	43
7.7.	D-CORVUS User Interface.....	44
7.8.	Front Panel Indicators	48
7.9.	Battery Information	48
CHAPTER 8 VEGAS Diode.....		49
8.	<i>Vegas Diode</i>	49
8.1.	Vegas Diode Overview	49
8.2.	Vegas Diode Operation	49
8.3.	Benefits.....	50
8.4.	Specifications.....	50

CHAPTER 9 TROUBLESHOOTING / SERVICE..... 51

9. TROUBLESHOOTING/SERVICE 51

 9.1. FAQ.....51

 9.2. Contact Information51

 9.3. Software Updates.....51

CHAPTER 10 DragoonITCN WARRANTY 52

10. DragoonITCN WARRANTY..... 52

 10.1. LIMITED WARRANTY52

 10.2. DragoonITCN CUSTOMER SUPPORT53

 10.3. EXTENDED WARRANTY54

11. GLOSSARY OF TERMS 55

 11.1. TERMS.....55



Table of Figures

Figure 1 CORVUS Unit.....	1
Figure 2 CORVUS Connector Panel	3
Figure 3 CORVUS Main Screen.....	4
Figure 4 On Screen Keyboard.....	4
Figure 5 D-CORVUS RX/TX.....	5
Figure 6 Vegas Diode	5
Figure 7 J-300 Battery Pack.....	6
Figure 8 Configuration Editor Icon.....	7
Figure 9 Configuration Editor Main Screen.....	8
Figure 10 Configuration Editor Example.....	9
Figure 11 Bus Monitor Example.....	10
Figure 12 Bus Monitor Icon.....	11
Figure 13 Bus Monitor Startup Screen.....	11
Figure 14 Bus View	12
Figure 15 Show Errors Screen	13
Figure 16 Command Breakdown	14
Figure 17 Bus Monitor Error Filter Popup.....	15
Figure 18 Bus Editor.....	16
Figure 19 Load Button.....	17
Figure 20 S Parameter Two Port Network	18
Figure 21 VNA Icon	19
Figure 22 VNA Main screen	19
Figure 23 VNA Calibration	20
Figure 24 VNA Main Screen	21
Figure 25 VNA Options Menu	22
Figure 26 VNA Creating Database	22
Figure 27 VNA Edit Database	23
Figure 28 VNA Edit Database	24
Figure 29 VNA Pass/Fail Parameters	25
Figure 30 VNA Pass/Fail Parameters Plot.....	26
Figure 31 VNA Saving a Trace.....	27
Figure 32 VNA Loading a Trace	28
Figure 33 VNA Insertion Loss Plot	29
Figure 34 Return Loss display	30
Figure 35 VSWR Display.....	31
Figure 36 Distance to Fault VNA Display.....	32
Figure 37 Wiremap Main Screen.....	33
Figure 38 Wiremap Icon.....	34
Figure 39 Wiremap Read.....	34
Figure 40 Wiremap Compare No Errors.....	35
Figure 41 Wiremap Compare Error	36
Figure 42 Wiremap Connector.....	36
Figure 43 D-CORVUS TX & RX.....	37
Figure 44 Aircraft Stub Connections	38
Figure 45 Insertion Loss	39
Figure 46 D-CORVUS Calibration Connections	40
Figure 47 USB Splitter	41
Figure 48 D-CORVUS Icon.....	41
Figure 49 D-CORVUS Application User Interface	42
Figure 50 D-CORVUS Plot options Combined	44
Figure 51 D-CORVUS Plot options Split	45
Figure 52 D-CORVUS Plot options Differential	45
Figure 53 Vegas Connections	49



Revision History

Revision	Section	Change	Date	Initials
REV – 1.0	ALL	Initial Version Release	01/07/25	BG
REV – 1.1	All	Updated Table of Figures	3/4/2025	TD



CHAPTER 1 INTRODUCTION

1. INTRODUCTION

1.1. CORVUS OVERVIEW

CORVUS is a small, one-man carry, easy-to-use test tool for aircraft avionics and weapon systems; a combination of hardware and software tools providing a complete MIL-STD-1553 troubleshooting/testing capability for any triax/twisted pair bus network and cable integrity testing capability. Overall, CORVUS includes four testing and troubleshooting functions (Bus Monitor, VNA, Wiremapping, and Stub Analysis) and associated cables. Detailed descriptions of these test capabilities are covered herein.

CORVUS-400 KIT

CORVUS-400 kits will include the following:

QTY Description

Qty	Part Number	Description
1	01-09362	Corvus C-9235-400
1	01-09838	Vegas Diode
1	05-07682	50 Ft Grounding Cable assembly
2	05-09450	Triax Cable 10'
1	05-09584	CORVUS 28V Power Brick
2	05-09889	Triax Cable 1Ft
1	05-10071	USB Cable, USB 2.0 Cable, USB A to B Cable
1	05-10075	Female Jack Y Splitter Hub Power Cord Extension Adapter Cable
2	05-10200	VNA Lead Cables
1	05-10247	Vegas Diode 5 VDC Adapter Cable
1	06-09988	D-CORVUS Transmit Unit
1	06-09989	D-CORVUS Receive Unit
3	52-09360	Power Cord Black 6'
2	55-10185	D-Corvus Chargers
1	55-10194	Portable Power Station
1	55-10295	Portable Power Station Charger
1	55-10296	Portable Power Station Vehicle Adaptor
1	77-09594	USB Silicone Waterproof Keyboard Touchpad
1	79-10199	VNA N911 Calibration Kit



Figure 1 CORVUS Unit

Size	18" L x 11.5" W x 5.5" D
Weight	18lbs
Power	60 W, 115 VAC or 28VDC

1.2. SAFETY & SECURITY

- SAFETY WARNING -

**REFER TO THE LOCAL SHOP SAFETY RULES AND REGULATIONS.
THIS DOCUMENT DOES NOT SUPERCEDE LOCAL REGULATIONS
FOR SAFETY.**

**USE REAR GROUNDING LINE OR SUITABLE REPLACEMENT PRIOR
TO POWERING ON CORVUS.**

1.3. OPERATION OVERVIEW

There are several safety guidelines which must be followed while operating CORVUS. These guidelines ensure a safe operating environment. Ensure all other applicable safety guidelines and rules are followed in accordance with your facility or in your operational environment.

1.4. Startup Procedure

1. Connect the Grounding Cable – Place the CORVUS on a stable surface.
2. Unscrew wing nut on the grounding post.
3. Place ringed end of grounding cable on the Grounding Post
4. Place the clamp on the other end on to earth ground.
5. Plug in the CORVUS - Connect the power cord to a standard 115VAC, 60Hz outlet. (If using battery pack connect the power cord to the output)
6. Connect the power cord to CORVUS power port.
7. Secure the power connection by hand tightening the lock on the connector until it is snug.
8. CORVUS is now connected to a power source.
9. Power on CORVUS by Pushing the silver button on the top panel.
10. Wait for boot up to complete.
11. When the CORVUS splash screen is loaded, the startup procedure is complete.



Figure 2 CORVUS Connector Panel

1.5. Shutdown Procedure

1. Close all CORVUS applications.
2. Power off the CORVUS by pressing the silver button on the top panel.
3. Unplug CORVUS – Disconnect the power cord from the outlet.
4. Unscrew and disconnect the Power Cord from the top panel.
5. Wrap up the Power cord and secure with Velcro strips.
6. Unhook the grounding line clamp from earth ground.
7. Unscrew wing nut and remove the grounding line from CORVUS.
8. Wrap up the ground line and secure with Velcro strips.

1.6. Main Menu

The CORVUS main screen appears within 40 seconds after the power button is pressed. Either the integrated touch screen or an external keyboard may be used to navigate the display. The external keyboard will use the USB keyboard connector on the adapter panel. The touch screen has an on-screen keyboard that is displayed when the user taps any alphanumeric input area on the screen. The Mouse function does not work with the on-screen keyboard.

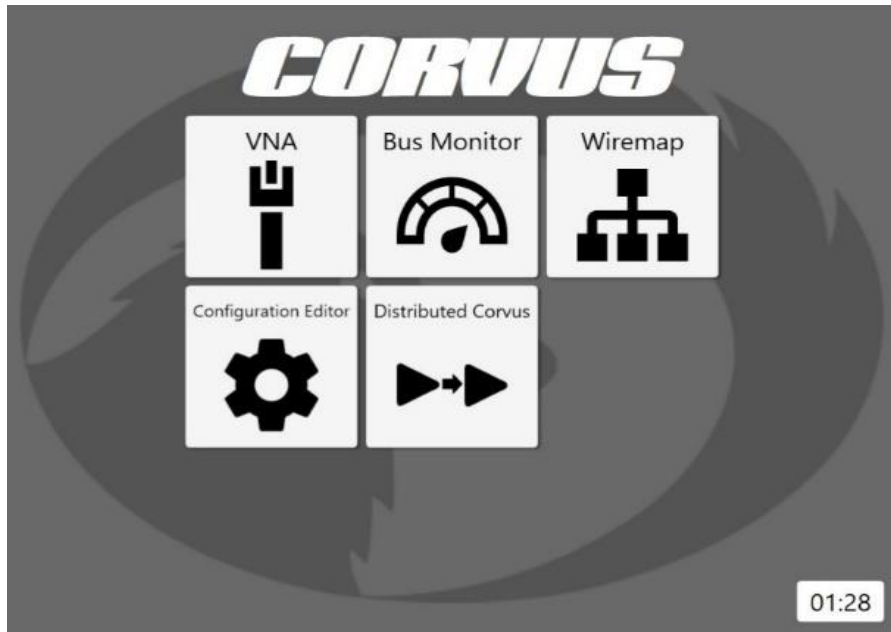

Figure 3 CORVUS Main Screen

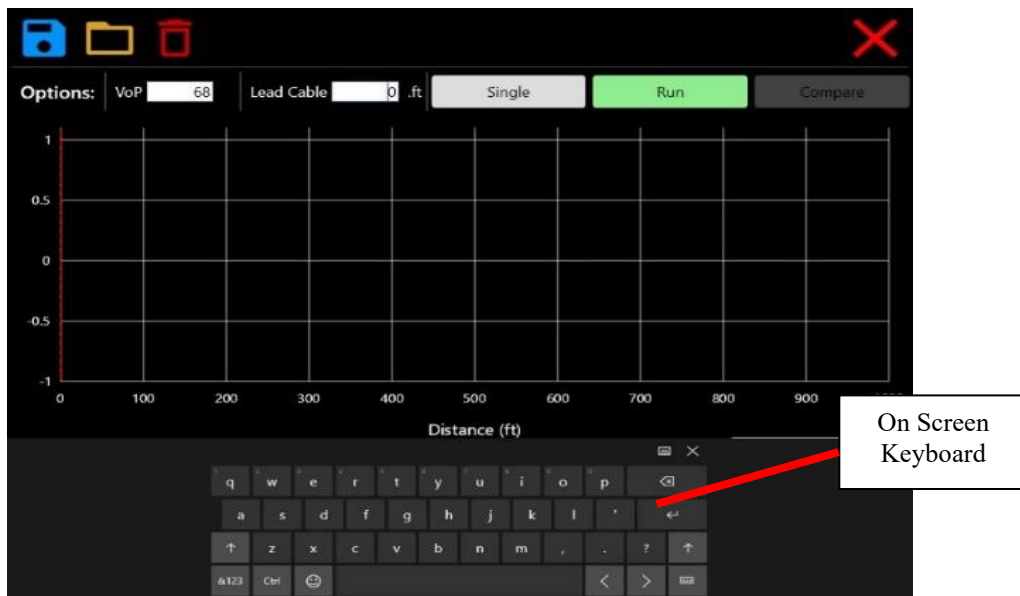

Figure 4 On Screen Keyboard

CHAPTER 2 ACCESSORIES

2. ACCESSORIES

2.1. D-CORVUS

The D-CORVUS is designed for testing and debugging an *inactive* MIL-STD-1553 data bus. The bus under test must be powered down. The D-CORVUS system is made up of a Transmit unit, a Receive unit and associated interconnect cables. The D-CORVUS system is designed to be controlled and used in conjunction with a CORVUS-400 Test Tool.



Figure 5 D-CORVUS RX/TX

2.2. Vegas

The Vegas is a Data Diode module that addresses concerns regarding use of untrusted, commercial-off-the-shelf (COTS) bus logging on aircraft with a MIL-STD-1553 or ARINC-429 bus interface. Use of a CORVUS-400 on USAF aircraft is approved when VEGAS is inserted between the Test Tool and 1553 Bus. The VEGAS included with the CORVUS-400 is non-ruggedized.



Figure 6 Vegas Diode

2.3. Battery Pack

The battery pack offers a versatile and portable power solution with multiple output options, including AC, USB-A, USB-C, and a car port. It is designed with safety features such as a Battery Management System, Over Voltage Protection, and Short Circuit Protection. The robust lithium-ion cells ensure a long cycle life, providing over 500 cycles with at least 80% of the original capacity. The Battery Pack alleviates the need for AC power at the aircraft.



Figure 7 J-300 Battery Pack

2.4. Travel Case

The CORVUS 400 Kit is enclosed in one rugged travel case. Below are the specifications of that case:

DIMENSIONS	MATERIALS	TEMPERATURES
31.59 x 22.99 x 19.48 in	Body Material: Polypropylene	Min Temp -40° F (-40 ° C)
WEIGHT	Latch Material: ABS	Max Temp 210° F (99 ° C)
42 lbs	O-Ring Material: Polymer	
OTHERS	Pins Material: Stainless Steel	APPROVALS
Wheels 4	Foam Material: 1.3 lb Polyurethane	Certifications
Extendable Handle	Purge Body Material: ABS	IP67 / Def Stan 81-41
	Purge Vent Material: 3 Micron Hydrophobic Non-Woven	

CHAPTER 3 CONFIGURATION EDITOR

3. Configuration Editor

3.1. Configuration Editor Overview

The Configuration Editor is the database system CORVUS uses to save Test data and 1553 Bus custom configurations and creating the Bus is the first task prior to monitoring. To use the features of this application we first need to create a database file.

3.2. Creating a Database

1. Select the configuration editor icon on the CORVUS main screen.

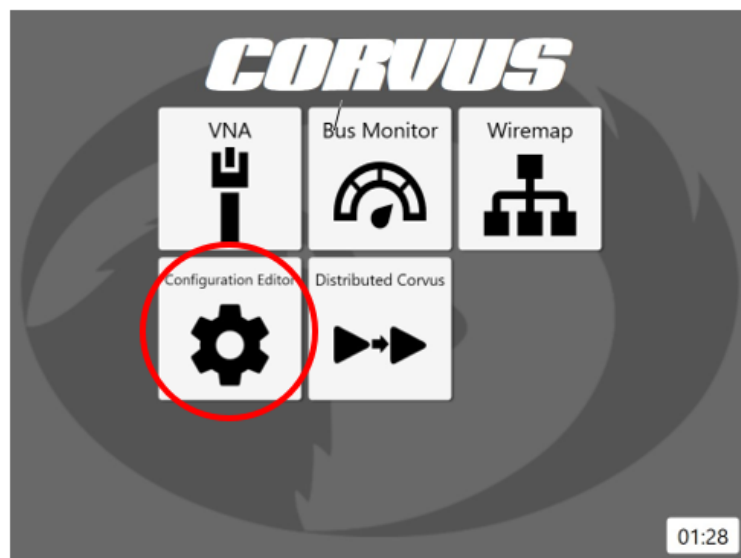

Figure 8 Configuration Editor Icon

2. When the application opens there will be a blank page for the user to edit.

Figure 9 Configuration Editor Main Screen

3. The User will need to enter information into each column of the database.
4. Select the + sign under Aircraft Type
5. Enter “Training Aircraft Type” in the pop-up and save. *Note: When supporting several aircraft types this helps to properly group the cable assemblies and networks to the proper aircraft.*
6. Select the + sign under Tail number.
7. Enter tail number “1234” and click Save.
8. Select the + sign under Bus.
9. Enter “Bus A”
10. Your screen should look like the following.

Cable Details			
Cable Type	1553	Segment Name	Start End
Cable Name	TDR Ethernet		
Cable Length	0 in		
Default VoP %	68		

Figure 10 Configuration Editor Example

11. Select Save and Enter the file name of the new database to create.
12. Select Save to save this database or cancel to discard.
13. The new database is now created and saved to the selected location.

3.3. Loading and Editing a Database

Existing databases may be loaded into the configuration editor in order to makes changes or additions. Once loaded, changes persist automatically to the file.

1. Select the configuration editor icon on the CORVUS main screen.
2. Select the load button.
3. Select the desired database file.
4. Make changes as necessary, described in Creating a Database
5. Close the Configuration editor by selecting the X in the upper right-hand corner.

CHAPTER 4 BUS MONITOR

4. Bus Monitor

4.1. 1553 Bus Monitor Overview

The CORVUS-400 Bus Monitor function provides features for dynamic MIL-STD-1553B bus analysis. This allows the user to quickly configure CORVUS and analyze the operation of the bus to identify bus traffic and errors for a given set of up to 32 remote terminals (RT). The application only monitors one data bus in the configuration that reflects the actual topology of the aircraft per Bus Monitor session. During 1553 bus monitor testing at aircraft, the buses under test must be powered up and active.

The Bus Monitor collects and displays bus health in an easily viewable format, to provide diagnostic capabilities for MIL-STD-1553B bus networks. This is accomplished using a non-intrusive monitor, which analyzes the bus traffic in comparison to MIL-STD-1553B protocol.

The CORVUS Bus Monitor GUI allows the user to define the bus topology in a graphical format representing the relative physical positioning of the various remote terminals on the bus. The bus topology can then be used to display bus statistics in an easy to read, color coded display.

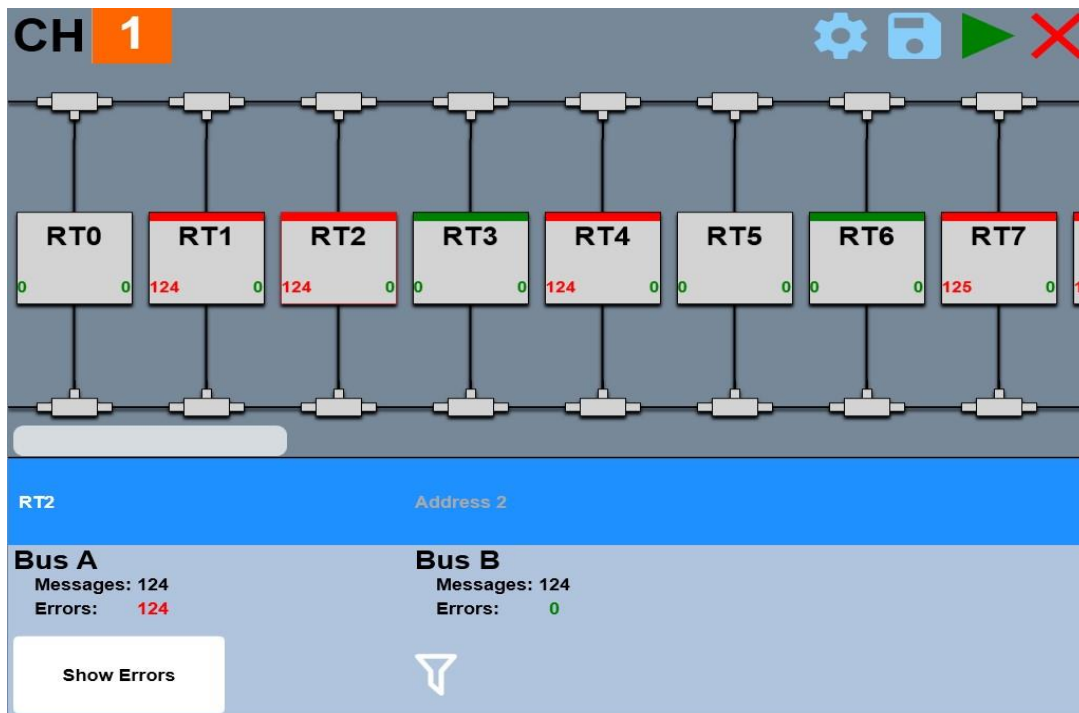

Figure 11 Bus Monitor Example

4.2. Starting A Bus Monitor Session

To start, locate the CORVUS 1553 connectors on the connector panel. The Model-400 will have two triax connectors labeled “PRI” & “SEC” for 1553 Bus monitoring.

1. Select the bus monitor icon. Wait while the bus monitor test loads.

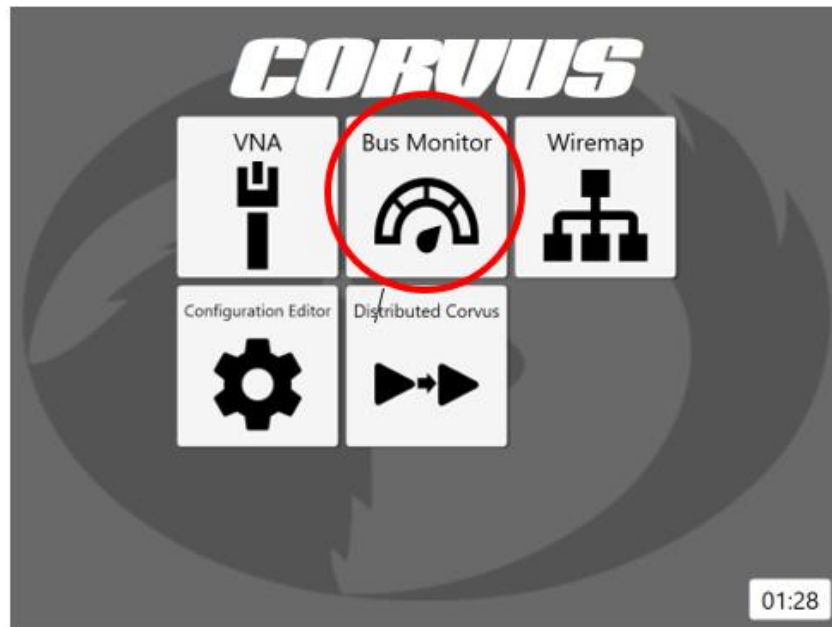

Figure 12 Bus Monitor Icon

2. Ensure the bottom left icon on the landing screen is green.

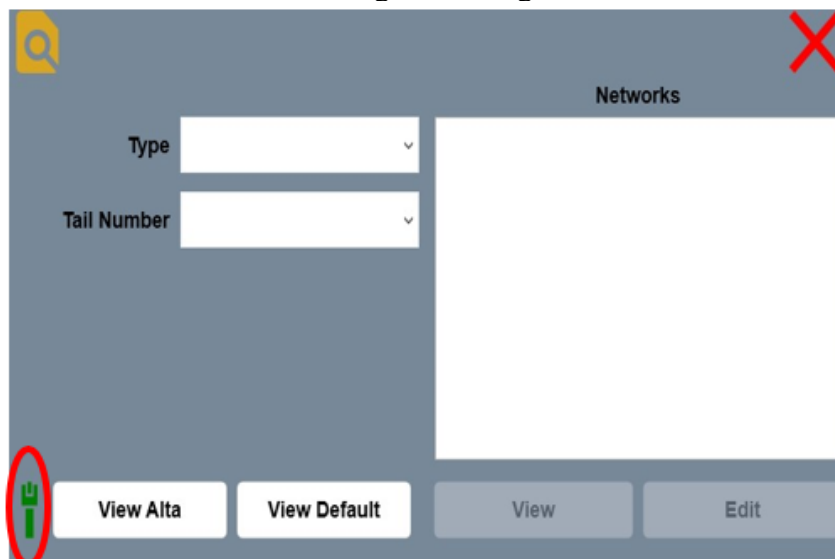

Figure 13 Bus Monitor Startup Screen

3. Select the “view default” button.
4. Observe a full, default bus with 32 terminals addressed from 0-31.
5. Select the green icon in the top right to start the monitor.

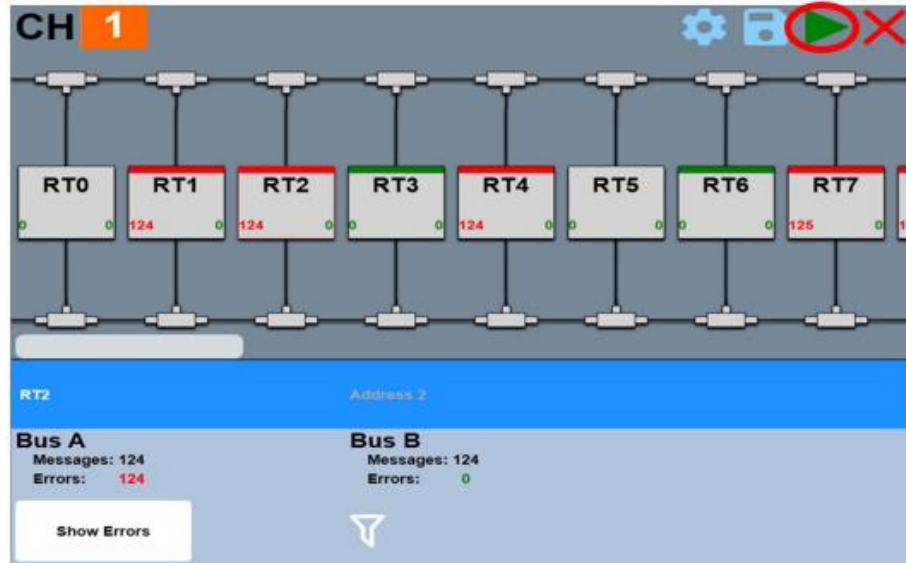

Figure 14 Bus View

6. Select the channel you wish to observe in the top left.
7. Select a terminal with activity, indicated by status icons in the top and bottom of each terminal.

4.3. Interpreting Bus Monitor Data

The bus monitor application is designed to present the relevant data for the configured bus for at-a-glance diagnostic. Once a monitor session has started, bus data quality indicators will be displayed on each terminal.

The top section of each terminal represents the primary bus data quality for that terminal. Likewise, the bottom section represents the secondary bus data quality. A green bar represents good data with no errors while a red bar represents one or more errors. If a terminal has no activity on a bus, there will be no color.

There is a numeric indicator on each terminal with the total number of errors received during the current session. This allows the user to interpret and diagnose previous errors in the session. Selecting a terminal will display the data for that terminal in a log at the bottom of the screen.

As messages are transmitted across the Bus each RT increments a count for total messages as well as errors. To view on a specific RT, click on the RT, then Errors click on the show errors button in the bottom left of the screen. It will open a window like the figure below:

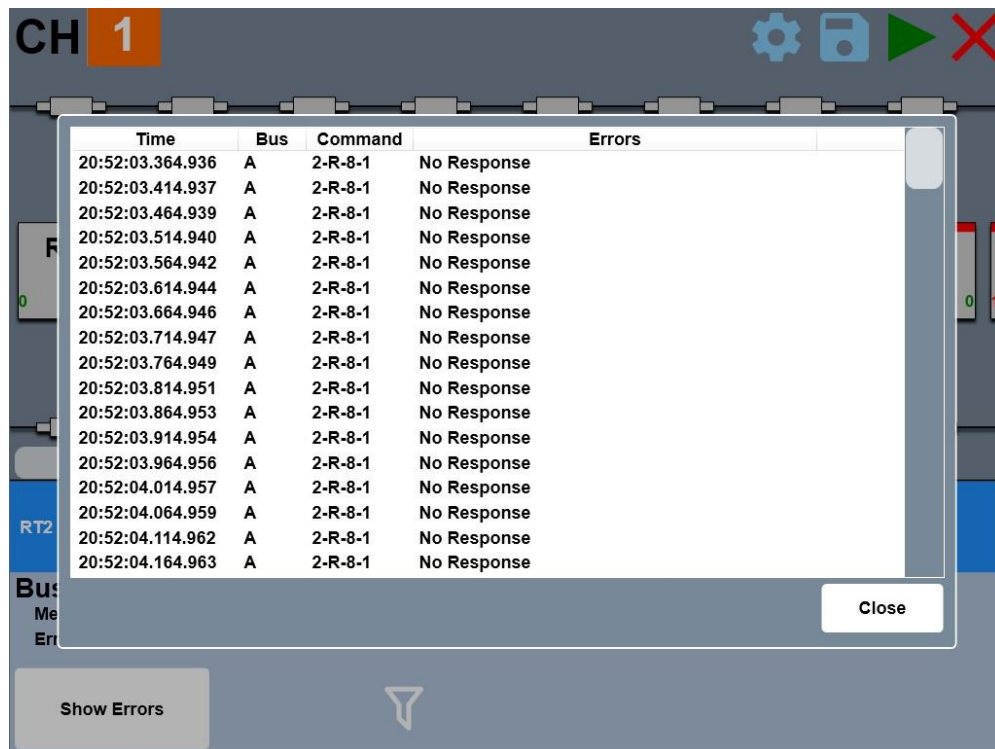

Figure 15 Show Errors Screen

The view in the Show errors screen breaks down the data into 4 columns. These columns are TIME, BUS, COMMAND, & ERRORS. The Time column represents when the message was logged. The Bus columns represent if the message was sent on Bus A or Bus B. The Command column represents the command word being sent. The Command word can be broken down into the following:

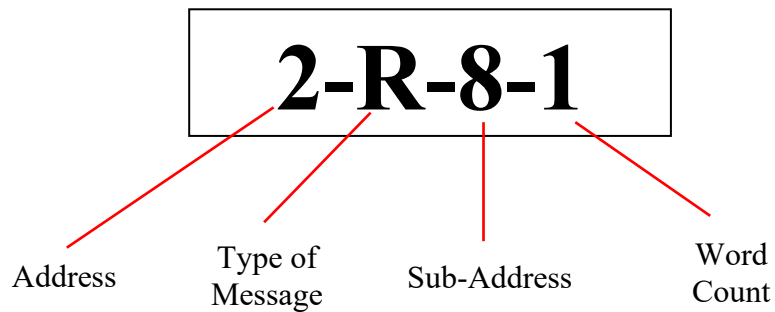

Figure 16 Command Breakdown

To view all the messages on the bus the data will need to be exported to a CSV file. The steps to perform this action will be covered in 4.6.

4.4. Filtering 1553 Data

The 1553 bus monitor function also allows filtering out any unwanted data. Once a custom bus configuration is implemented, only data for configured terminals will be included. Errors that are inconsequential to the user may be filtered out by configuring the error filter.

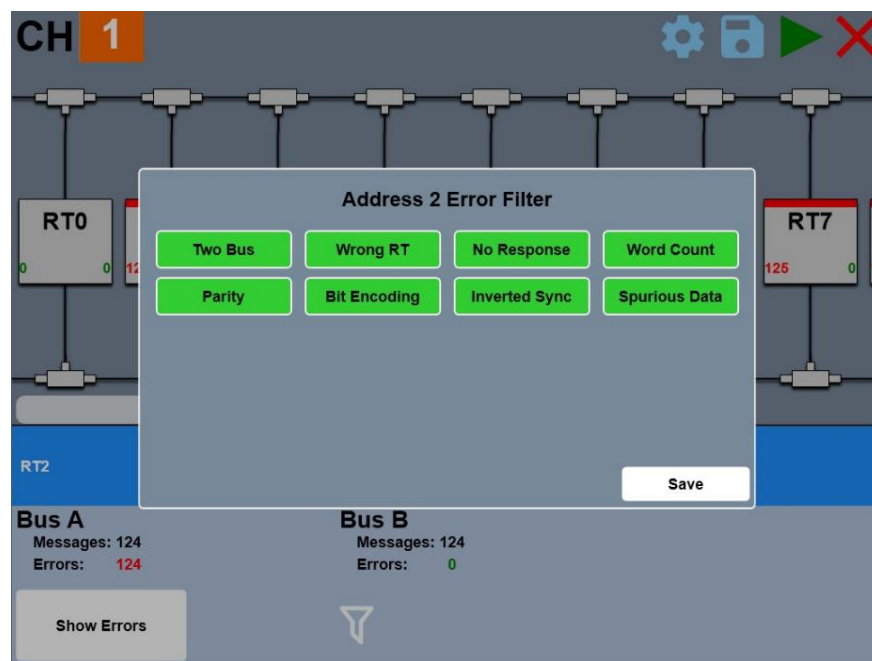

Figure 17 Bus Monitor Error Filter Popup

4.5. Custom Layout

The CORVUS bus monitor GUI allows the user to define the bus topology to represent the relative physical positioning and metadata of the remote terminals and couplers on the physical bus. The bus topology can then be used to display bus statistics in an easy to read, color coded display that more closely resembles the physical bus.

A database is required to customize the bus topology. This can be generated in the configuration editor application from the main screen. See the Configuration Editor Chapter for more information.

1. Select the file icon in the top left of the bus monitor landing screen.
2. Select your database from the file explorer and select open.
3. Select the aircraft type, aircraft, and network you wish to customize.
4. Select edit.

5. Select the bus redundancy desired.

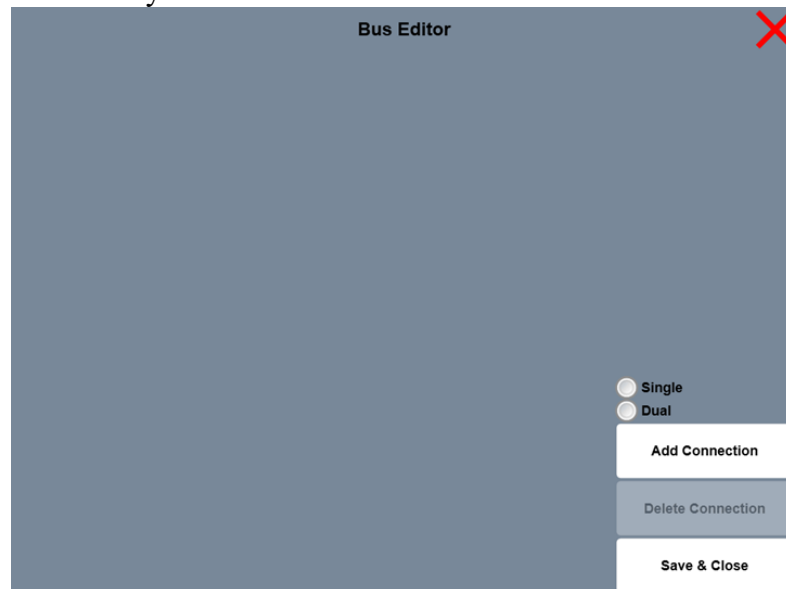

Figure 18 Bus Editor

6. Select the “add connection” button for each terminal the physical bus contains.
7. Select each terminal and edit the name, address, and order as desired.
8. Select the save & close button.
9. Select the view on the main screen.
10. Follow instructions in starting a bus monitor session to see your filtered, relevant data.

4.6. Exporting 1553 Data

The CORVUS-400 can export the metadata and raw data words from a bus monitor session to a .CSV file from the 1553 collected data. This requires an SD card to store the data (found on the CORVUS-400 bulkhead).

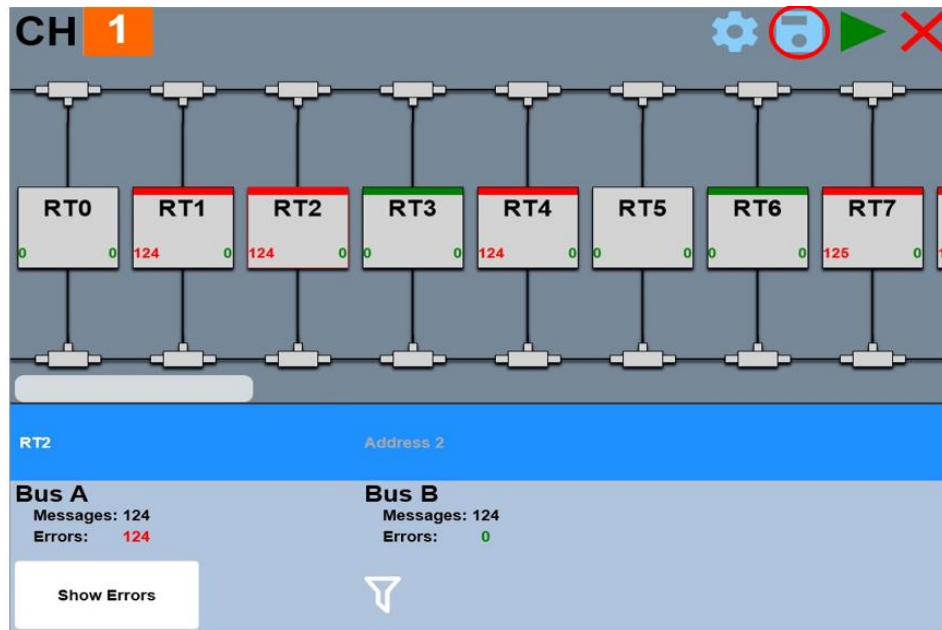

Figure 19 Load Button

After a bus monitor session has been stopped the save icon will be enabled if any data is captured. Selecting this icon automatically exports to the SD card under:

D:/DragoonITCN/CORVUS/1553Exports/yyyymmdd-time-1553BusData.csv

CHAPTER 5 VECTOR NETWORK ANALYZER

5. Vector Network Analyzer

5.1. Vector Network Analyzer Overview

The CORVUS-400 VNA function measures the relative amplitude and phase of complex signals, using its capability to generate signals of a given amplitude and phase, inject them in a DUT, and measure response to calculate the complex impedance at the measurement frequency. The relationship between the injected signal and response is the S-parameter, typically given with two subscripts as S_{ij} , where the first subscript is the signal-injection port number “i” on the DUT and the second subscript is the response-measurement port number j. CORVUS generates a 100MHz-6GHz waveform and can measure all four S-parameters for a passive two port device, i.e., S_{11} , S_{12} , S_{21} , and S_{22} .

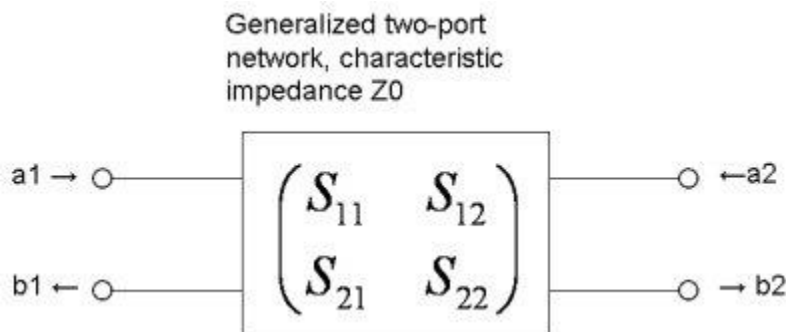

Figure 20 S Parameter Two Port Network

The VNA use case for Triax/Coax/Ethernet cable characterization measures the S_{11} (or S_{22}) parameter of the cable under test, i.e., the relation between the injected signal and a reflected signal measured at the single injection point at the end of the cable. The S_{11} or S_{22} parameter is well suited for insertion loss, VSWR measurement as well as impedance anomaly location. Tests that are specific to aircraft maintenance are covered in the following sections.

5.2. Software Setup

To start, locate the CORVUS VNA Calibration block, VNA lead cables, & VNA connectors on the connector panel. The Model-400 will have two connectors labeled “Port 1” & “Port 2”.

1. Select the VNA monitor icon.

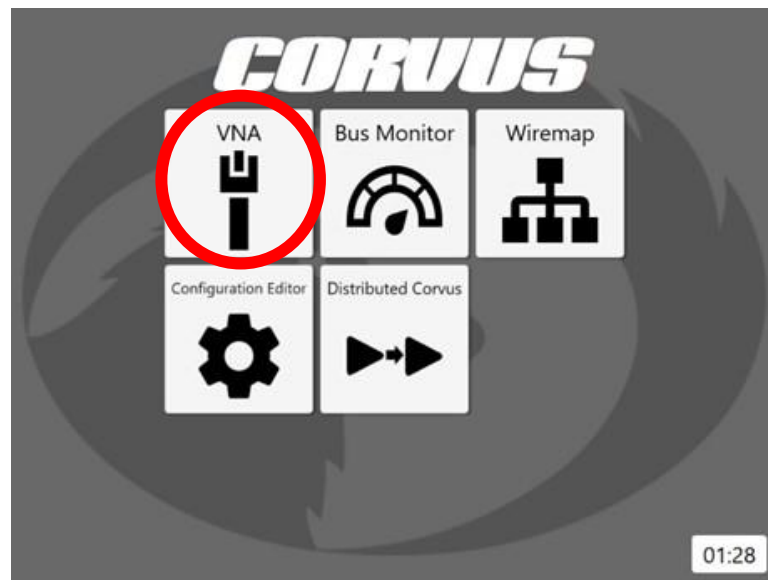

Figure 21 VNA Icon

2. Wait while the VNA application loads

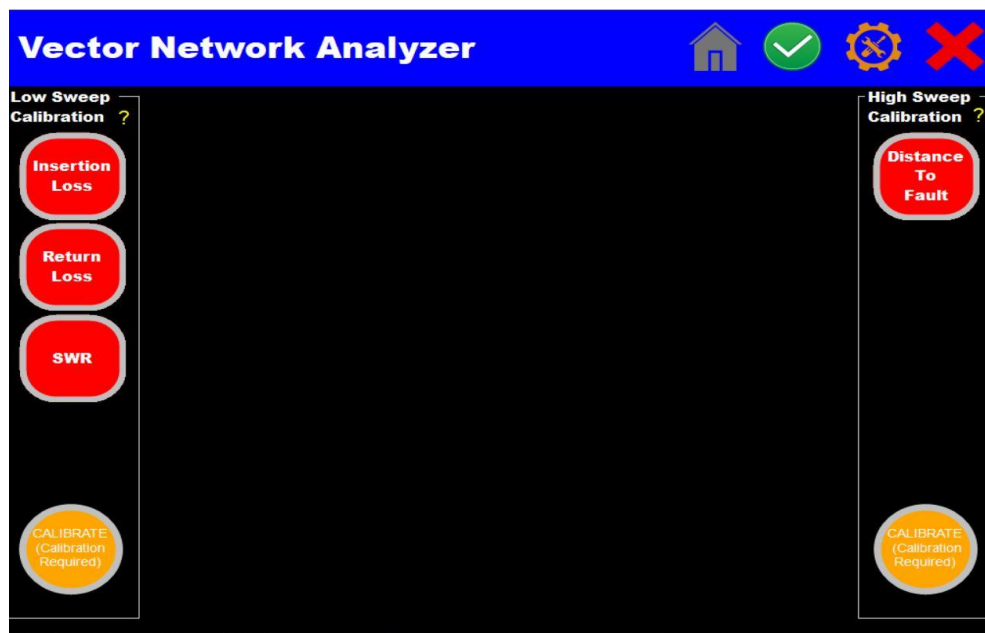

Figure 22 VNA Main screen

- Test parameters are separated into two groups. Insertion Loss, Return Loss, and SWR are all the same test parameters. Distance to Fault has its own test parameters. **Note:** If you change test group Calibration must be completed again
- Enter a start/stop frequency and database if created. **Note:** If a database has not been created follow *Creating Database Section*

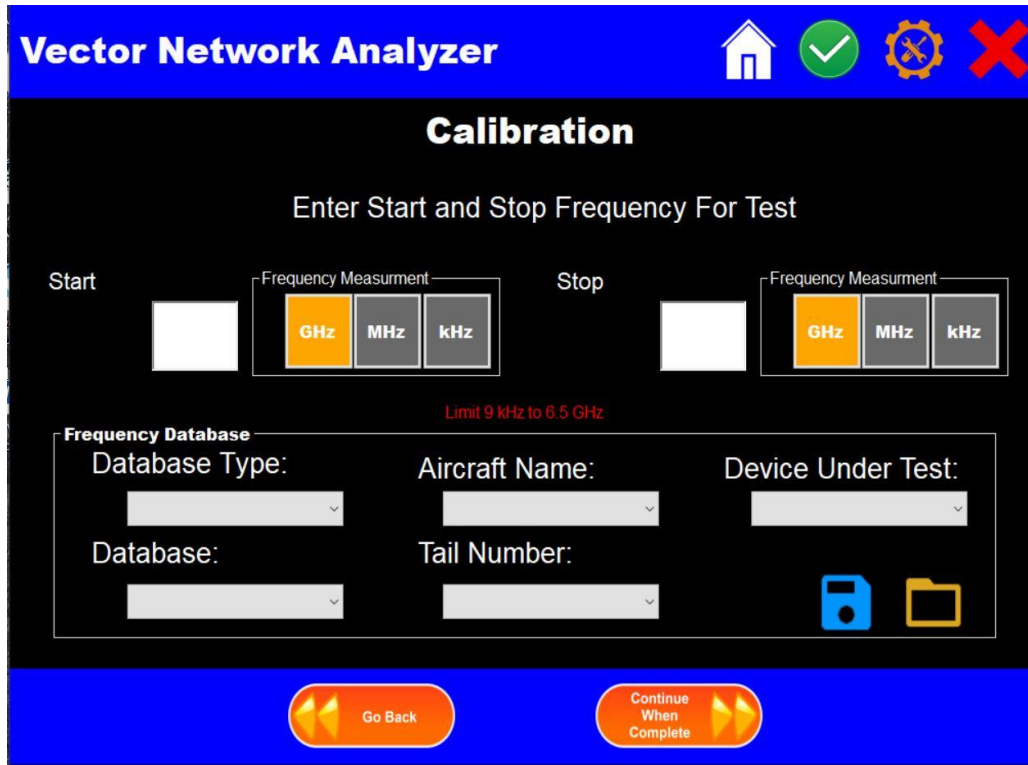

Figure 23 VNA Calibration

- Connect Lead cables to VNA Port 1 and Port 2



- Utilize Calibration kit provided and follow prompts on screen to complete calibration

5.3. Creating a Database

To save test results a database must first be created.

To create a database

1. Click Options Menu

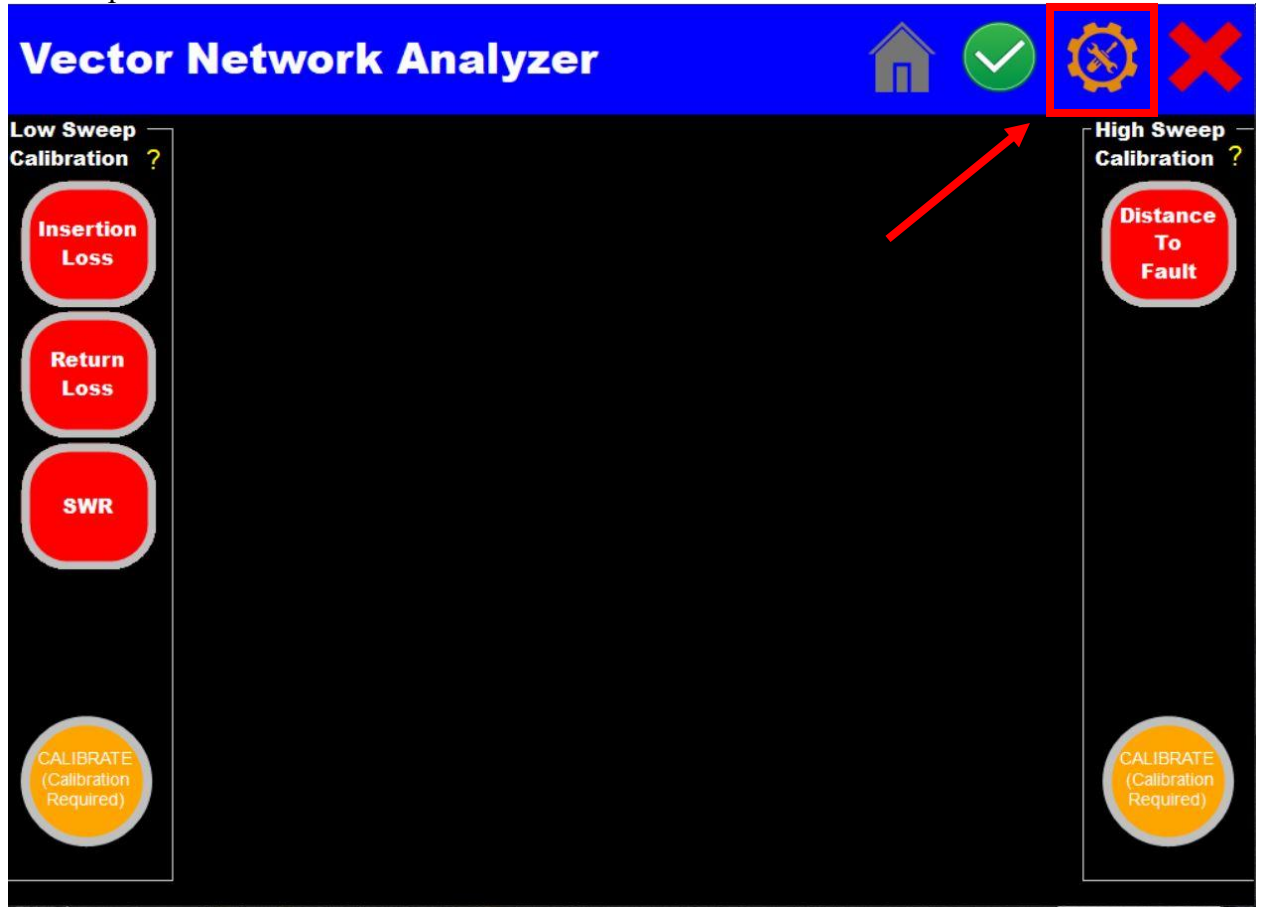

Figure 24 VNA Main Screen

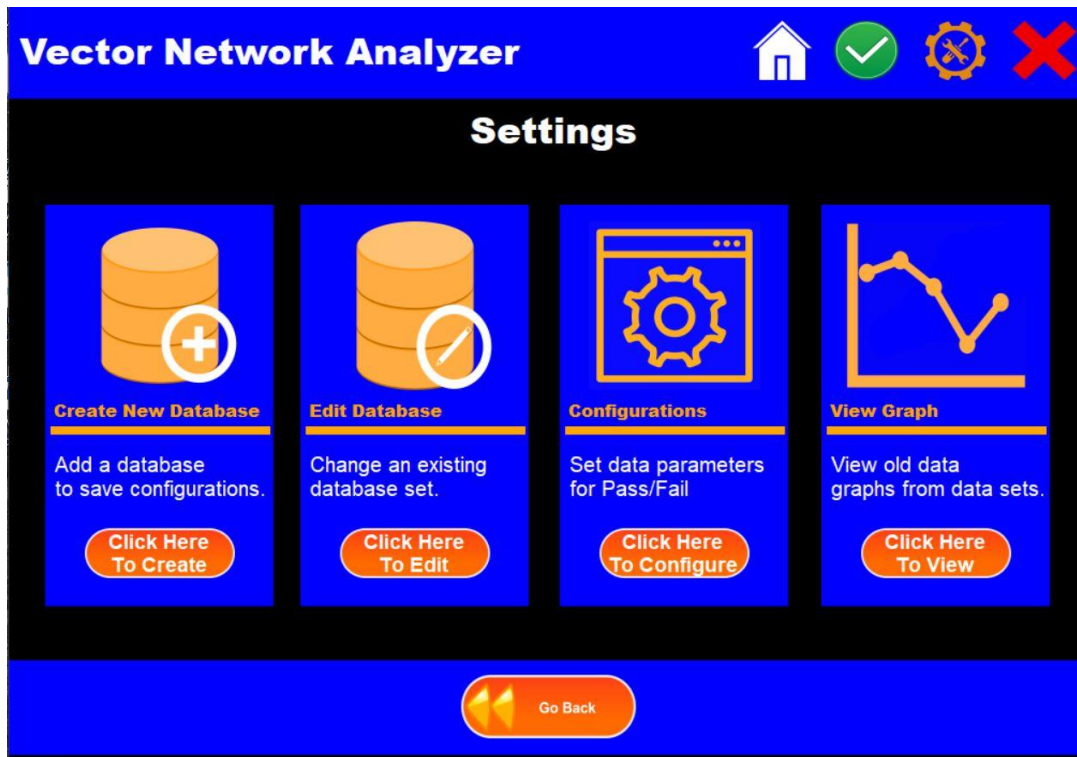

Figure 25 VNA Options Menu

2. **Select** Create New Database on the far left

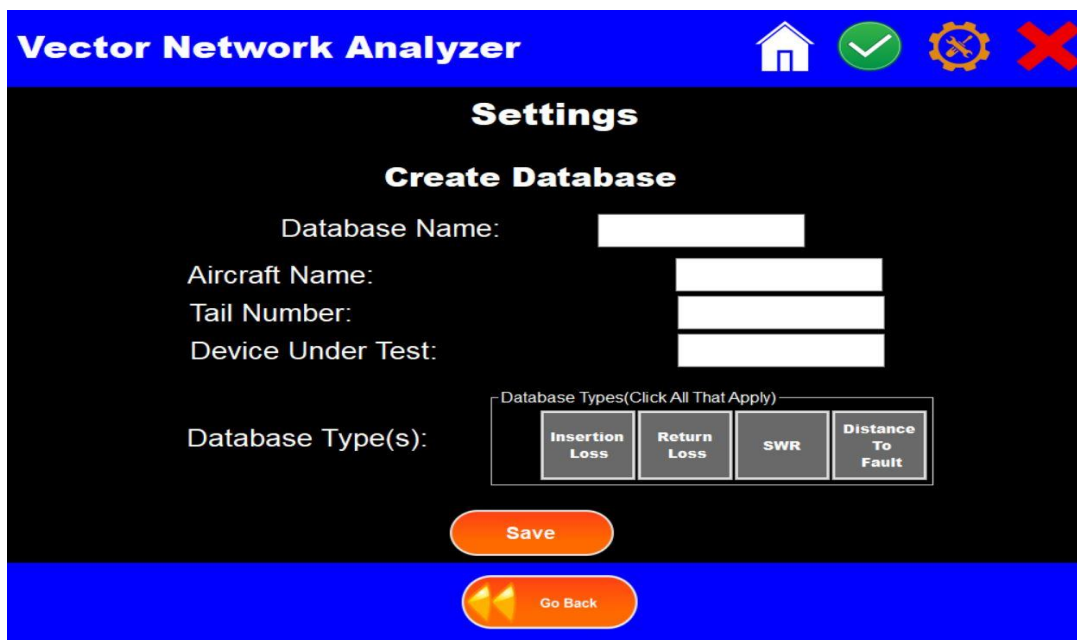

Figure 26 VNA Creating Database

3. **Enter** the information required and click save

5.4. Editing a Database

1. Select Edit Database from the options menu in figure 25

Vector Network Analyzer

Settings

Edit Database

Database Type:

Update Type:

Database:

Aircraft Name:

Tail Number:

Device Under Test:

Save **Delete** **Reset**

Go Back

Figure 27 VNA Edit Database

2. Select your existing Database File

Vector Network Analyzer

Settings

Edit Database

Database Type: Insertion Loss ▾

Update Type: File ▾

Database: NewTest ▾

Aircraft Name: C130 ▾

Tail Number: 0001 ▾

Device Under Test: ANT1 ▾

Save Delete Reset

Go Back

Figure 28 VNA Edit Database

Update Type selects which information you can edit

File- Edits Database Name

Entry- Edits Aircraft Name, Tail number, and Device Under Test

Enter the new information in the blank boxes on the right

Select the “Save “button

5.5. Pass/Fail Parameters

1. **Select** Configurations from options menu in Figure 25
2. **Enter** correct Pass/Fail parameters for DUT

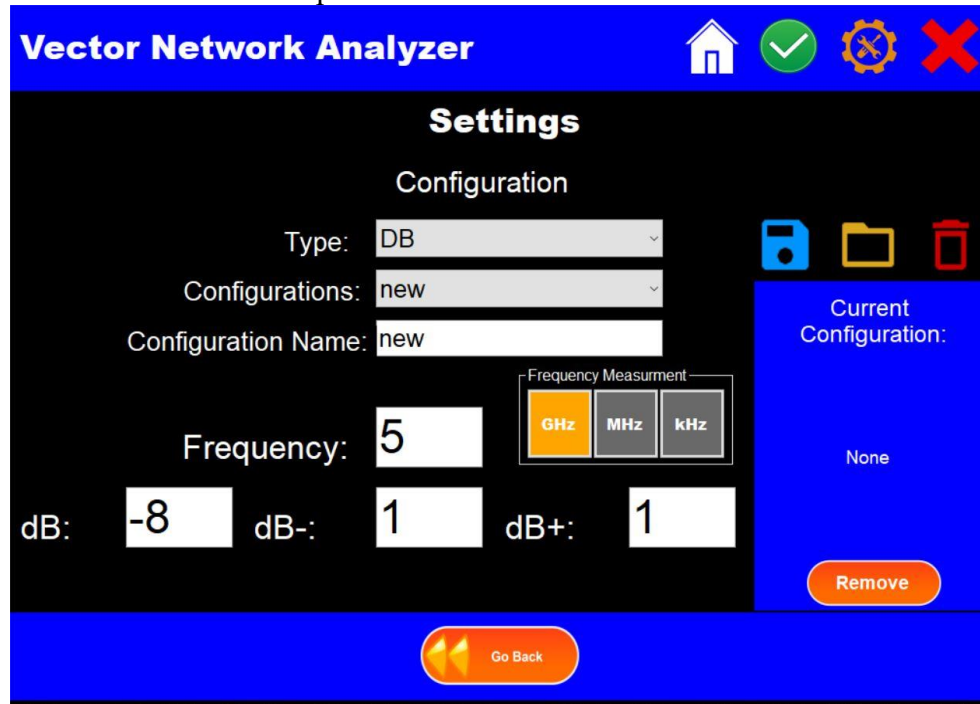

Figure 29 VNA Pass/Fail Parameters

3. **Click** blue Save icon when finished

Select the file icon in the middle to load selected config

Select the trash icon to completely erase current config

Select remove button to unselect current config

Pass/Fail Status is shown in the bottom right corner of the screen

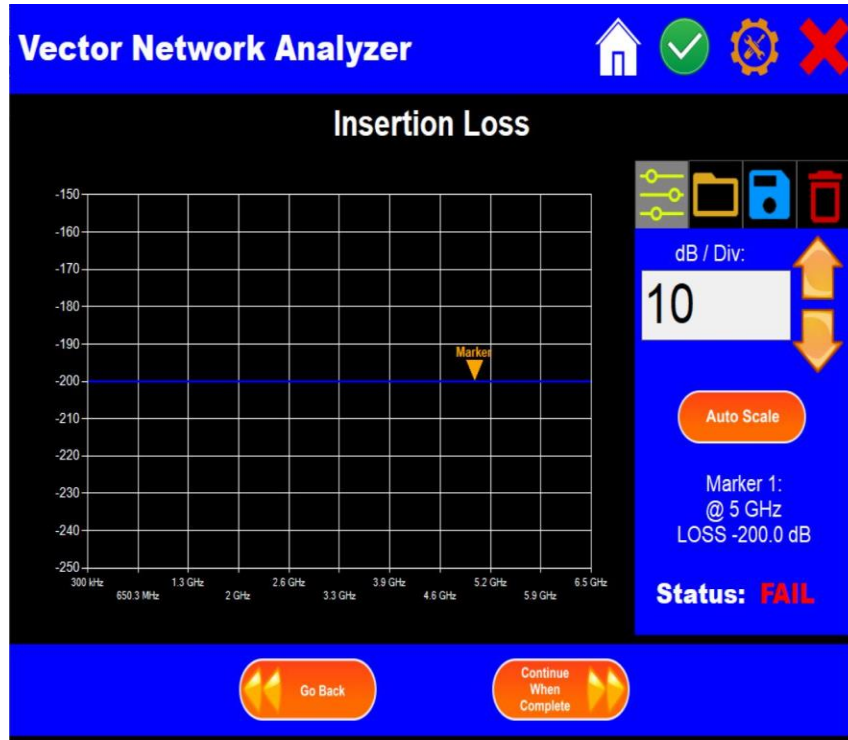

Figure 30 VNA Pass/Fail Parameters Plot

5.6. Saving a VNA Trace

To save a trace **Select** the blue save icon on the right side

Enter applicable Database info

Click Save button when you are finished

Note: A Database must be created first to be able to save

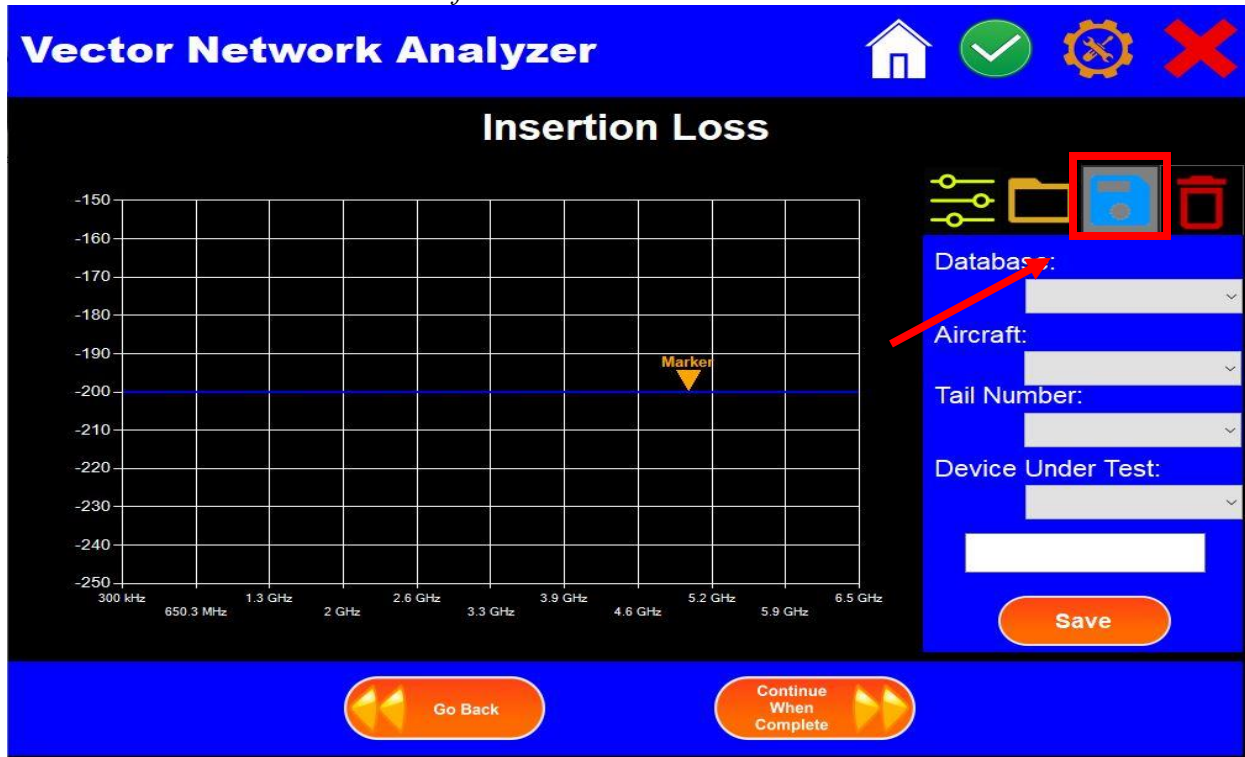

Figure 31 VNA Saving a Trace

5.7. Loading a VNA Trace

To load an already saved VNA trace **Select** the yellow file icon
Enter applicable information and **Select** the reference trace
 When you are finished **Select** Load button near the bottom

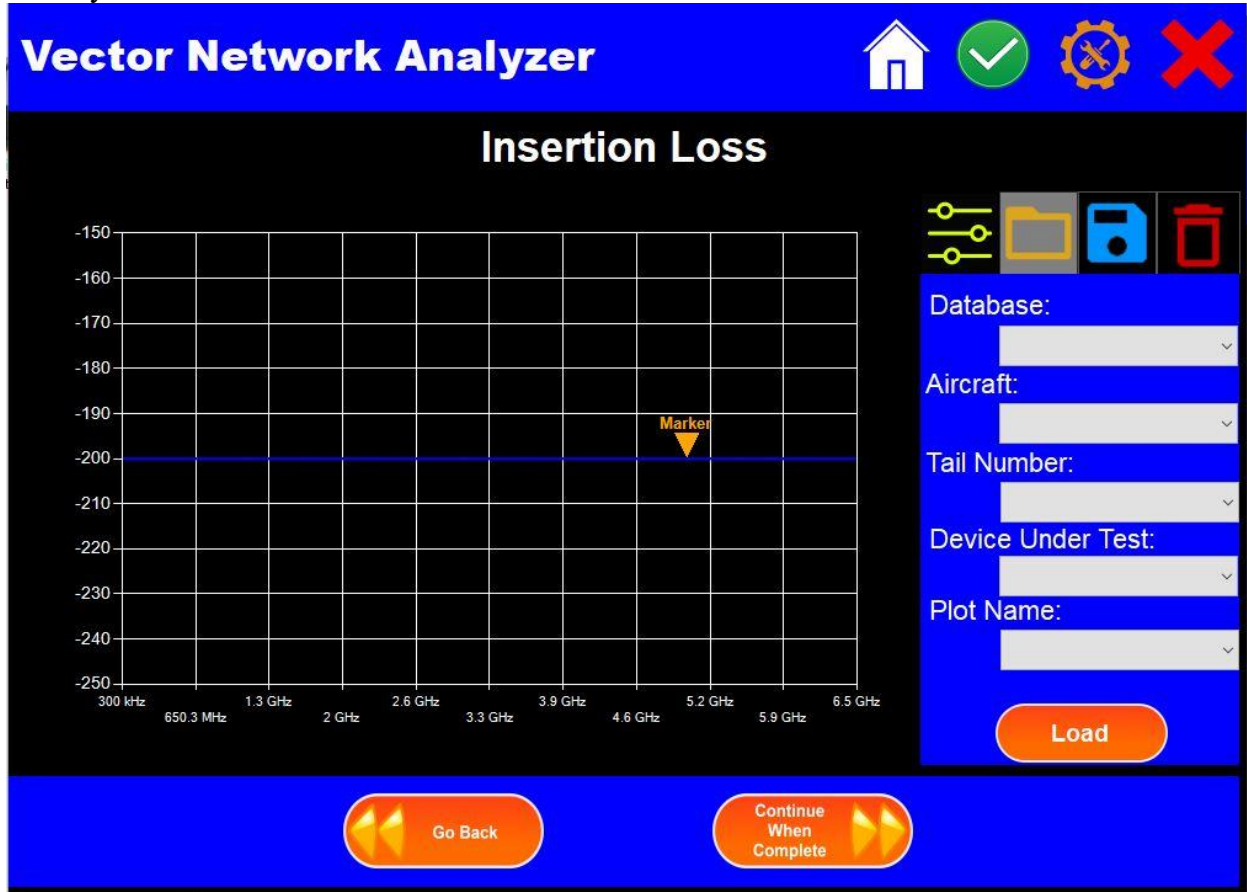

Figure 32 VNA Loading a Trace

5.8. Insertion Loss

The most common mode for VNA testing with CORVUS-400 operates on a two-port UUT, with the test signal injected on one end of the device or cable under test, and measurements of the response signal taken from the output port of the passive device or cable under test. This mode measures the S12 parameter (or S21 parameter if the port labels for injection and measurement in the DUT are reversed). Insertion Loss in dB is measured and displayed as shown below. Most common uses for this test are where 1553 Couplers are suspect, especially the 12dB stub port

1. **Click** Calibrate on the left test group
2. Connect lead cable to Ports 1 & 2
3. Follow Calibration prompts
4. **Click** on Insertion Loss Button
5. Connect the Device under test (DUT) between the two cables

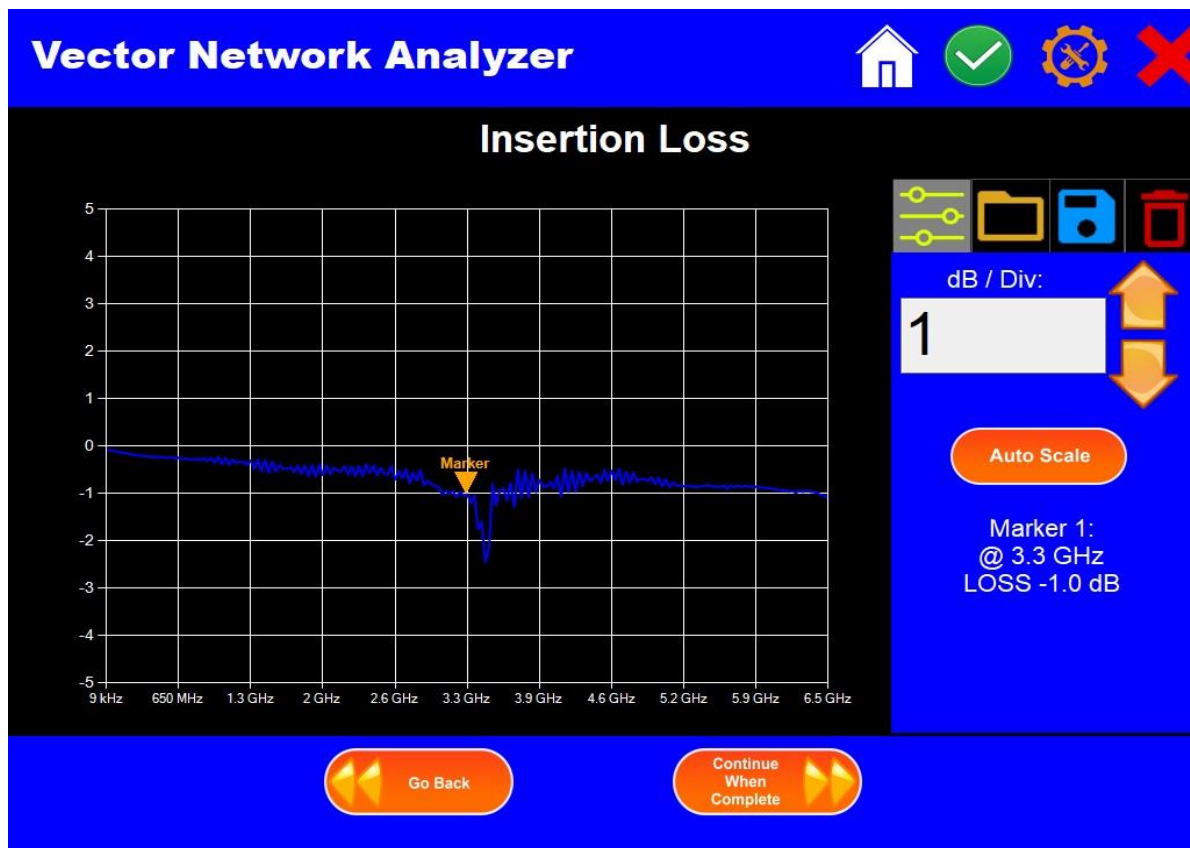

Figure 33 VNA Insertion Loss Plot

5.9. Return Loss & Standing Wave Ratio

In all RF systems as found on aircraft, it is critical that the source impedance and the load impedance match for desired performance. This applies to transmitters and receivers with coax connections to antennas. The CORVUS-400 VNA test capability includes a mode designed for this purpose; Return Loss/VSWR. In terms of S Parameters, S11 (Input) or S22 (Output) are measured with a signal comprised of frequencies that match the intended use. For example, GPS receivers are centered at 1.5GHz – so CORVUS automatically sets the stimulus to a narrow band signal centered at 1.5GHz as shown in the display below. Several common aircraft RF modules are offered in this test mode (i.e. UHF/VHF SATCOM, ADF, NAVCOM, etc.). Return Loss is measured in dB and should be nominally high (20-40dB) as it is a portion of the source power reflected from the load. VSWR is measured on the same screen and ranges from 1:0 (matched) to 6:1 where 50% of the source is reflected from the load. Opens and shorts on RF cables will be displayed as INFINITY on the VSWR display.

The trace in the figure below shows a Return Loss measurement of a cellular antenna matched between 806-869 MHz. The Return Loss amplitude scale is setup to go from 0.5 dB to 28 dB.



Figure 34 Return Loss display

The VSWR display in the right graph measures the same antenna and the amplitude scale has been set up to match the scale of the Return Loss measurement. The two graphs illustrate the relationship between VSWR and Return Loss.

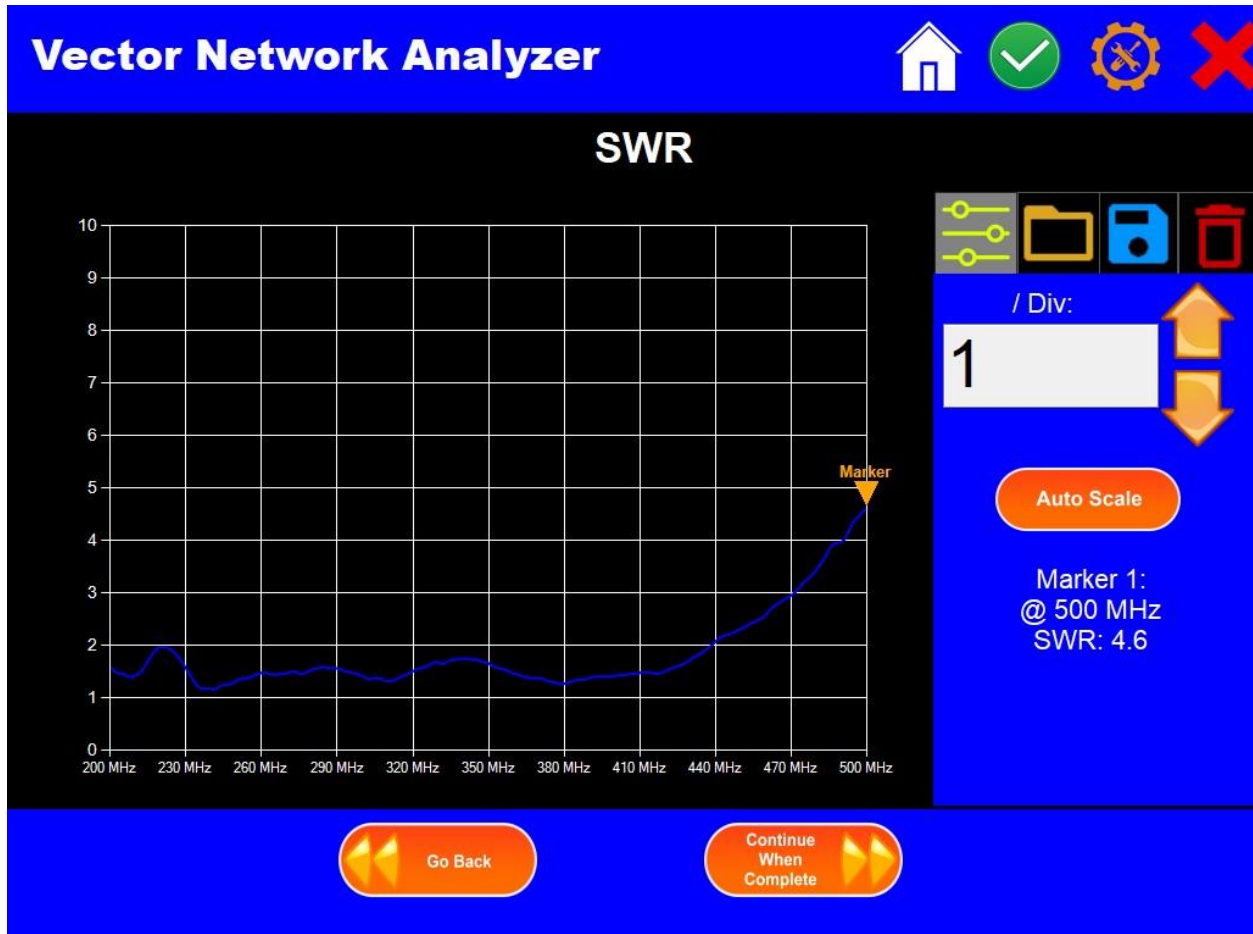

Figure 35 VSWR Display

5.10. Distance To Fault

A useful diagnostic display in CORVUS VNA test mode is shown below, which depicts a detected mismatch in the cable impedance (as a function of distance) for a 4-pair DVI cable. Peaks in the impedance measurement stand out as impedance anomalies attributable to connectors between segments of a multi-segment cable or other irregularities representing possible cable damage. **Note: Distance to Fault is still a work in progress**



Figure 36 Distance to Fault VNA Display

CHAPTER 6 WIREMAP

6. Wiremap

6.1. Wiremap Test Overview

The wiremap test is used to determine if a cable connector assembly is wired properly by performing continuity checks on all conductors. The CORVUS unit will scan the test cable for point-to-point conductors and display found connections in the UI. The user can compare a historical golden-standard wiremap to the currently connected cable to display any potential faults in the cable assembly. This includes shorts, opens, or misconnected wires.

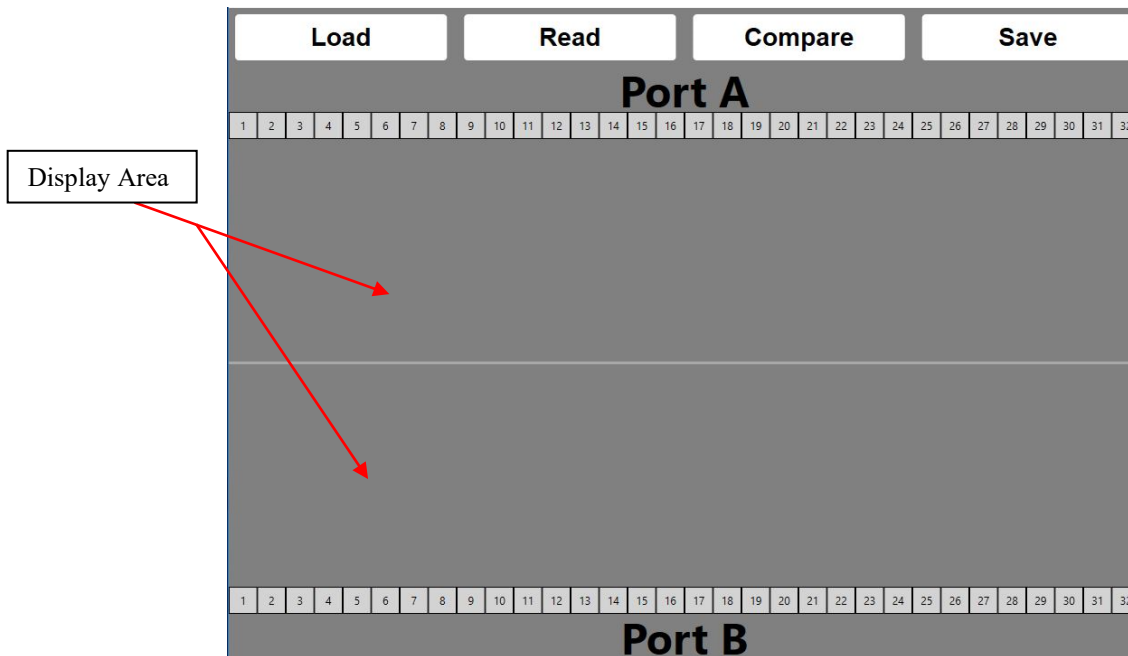

Figure 37 Wiremap Main Screen

Load	Loads a reference scan
Read	Takes a single scan of currently connected cable assembly
Compare	Compare current scan with a reference scan
Save	Saves current scan as a reference
Port A	Display connection corresponding with the Port A connector pins 1-32
Port B	Display connection corresponding with the Port B connector pins 1-32
Display Area	This area will display which pins are connect to each other.

6.2. Performing a Wiremap Test

Once an adapter cable has been built, the test is easy to run.

1. Select the Wiremap icon on the CORVUS main menu.

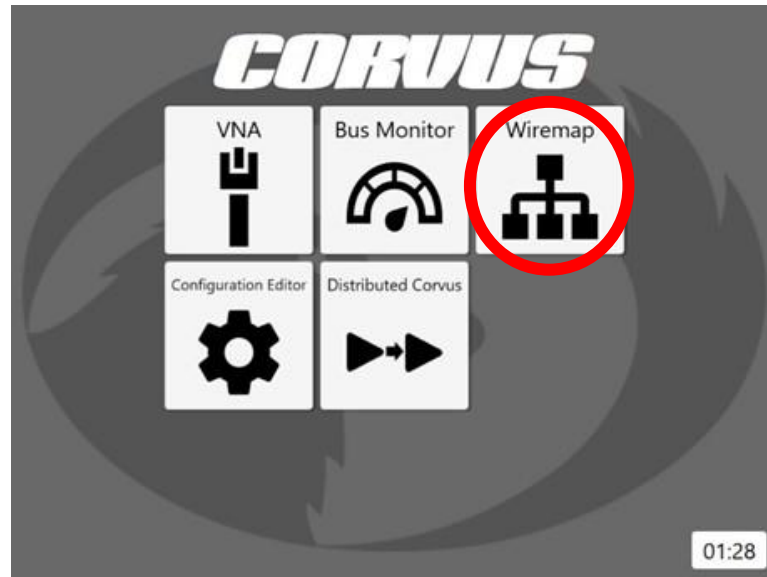

Figure 38 Wiremap Icon

2. Select the “read” button to scan the cable’s conductors. A screen like the figure below should populate.

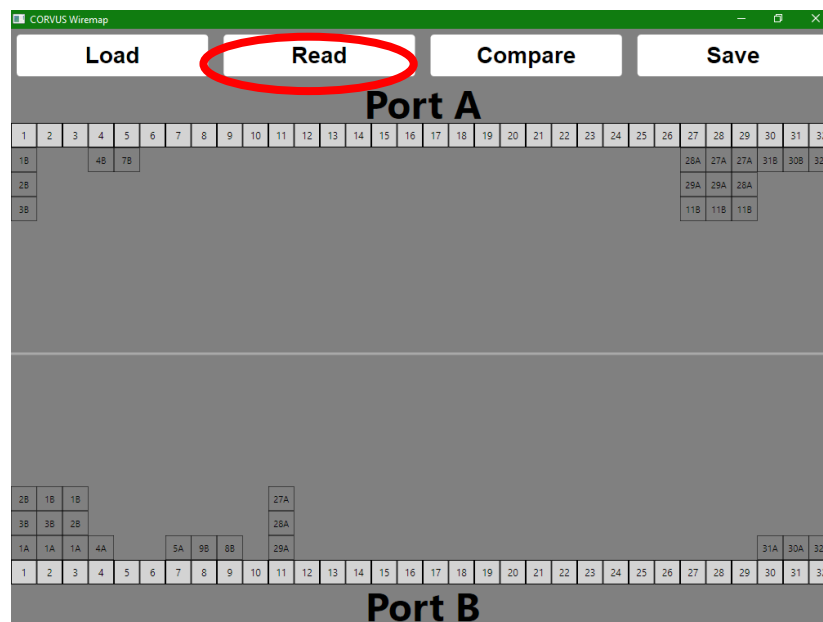

Figure 39 Wiremap Read

6.3. Interpreting Wiremap Results

Below is a properly compared cable with no unexpected or missed connections.

1. **Select** the “Save” button. Enter a filename to accurately label the wiremap data.
2. **Select** the “compare” button and select the file you just saved. A screen similar to the figure below will appear.

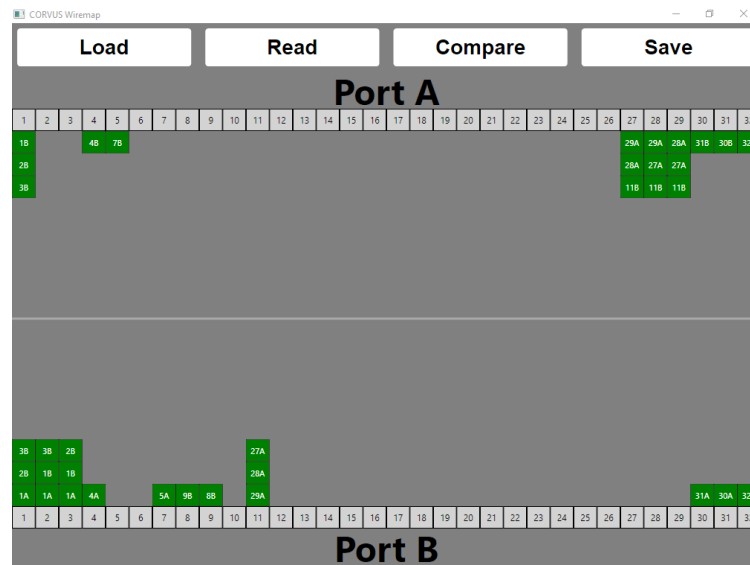

Figure 40 Wiremap Compare No Errors

Below is a figure representing an incorrectly fabricated cable. Dark red connection squares indicate connections that are expected to be there but are not. Light red connection squares indicate connections that are in the source cable but not the compared historical wiremap.

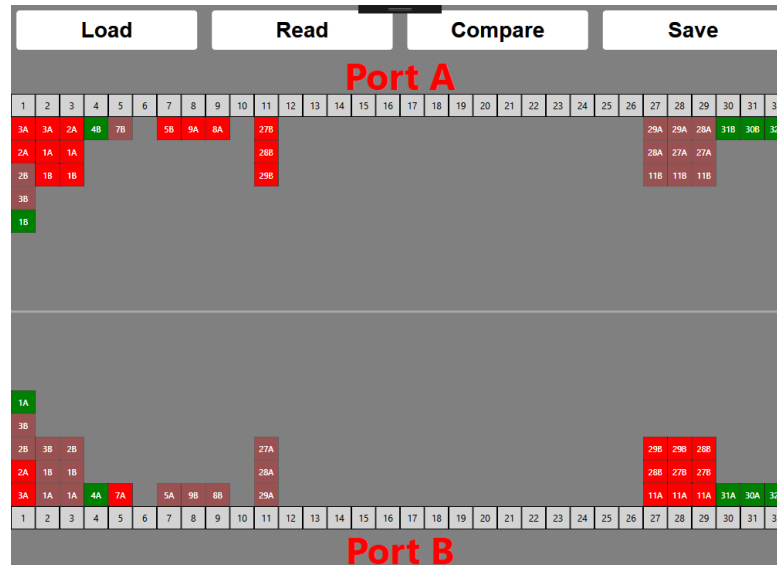

Figure 41 Wiremap Compare Error

6.4. Wiremap Interface Cable Construction

For the wiremap function to be employed, adapters for each end of the cable under test must be fabricated. The CORVUS-400 unit uses two Mil style circular connectors PN: MS27656T15B35P for the wiremapping interface. Wiremap A connector is shown in the wiremap application as Port A pins 1 through 32. Wiremap B connector shown in the wiremap application as Port B pins 1 through 32. The following shows the pinout of the Wiremap A and Wiremap B connectors as viewed from the topside of the CORVUS-400 connector panel.

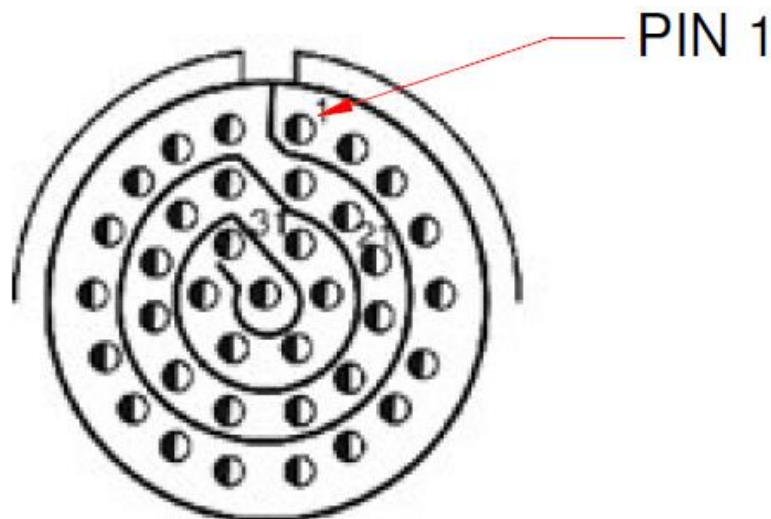

Figure 42 Wiremap Connector

CHAPTER 7 D-CORVUS

7. D-CORVUS

7.1. D-CORVUS Overview

The D-CORVUS is designed for testing and debugging an *inactive* MIL-STD-1553 data bus. The bus under test must be powered down. The D-CORVUS system is comprised of two units and associated interconnect cables. The D-CORVUS system is designed to be controlled and used in conjunction with a CORVUS-400 test tool. The CORVUS unit runs the application software and controls the D-CORVUS RX unit.

One of the D-CORVUS units is called the TX unit, and it functions as a source of 1553 like data pattern. This data is used to stimulate the bus under test. The TX unit is connected to any bus stub where its data is distributed across the bus and can be received by all other bus stubs.

The other unit is called the RX unit, and it is connected to various 1553 bus stubs where it receives the pattern of 1553 data from the TX unit.

By connecting the TX unit and RX unit to various bus stubs the bus can be tested for proper signal loss, polarity and bit errors count. Using the two D-CORVUS units a 1553 bus problem is quickly isolated to the stub, coupler, or section of main bus where the problem exists.

Key Features

- Insertion loss measurement
- Signal polarity
- Bit error measurement
- Digital Oscilloscope display
- Battery Powered



Figure 43 D-CORVUS TX & RX

P/N	Name	Description
06-09987	TX	Transmits 1553 pattern data for test.
06-09988	RX	Receives 1553 pattern data and measure loss.
05-10075	USB Y Cable	Splits CORVUS keyboard port for keyboard and Rx unit.

7.2. Aircraft Bus Testing

Before connecting the D-CORVUS system to the Aircraft bus make sure the bus is in a powered down state. This requires the bus controller and all remote terminals be in the powered down state. The D-CORVUS is designed to connect to the 1553 bus through the bus stub connections. One bus stub connection is used to connect the TX unit and another bus stub connects the RX unit as shown in the Figure below:

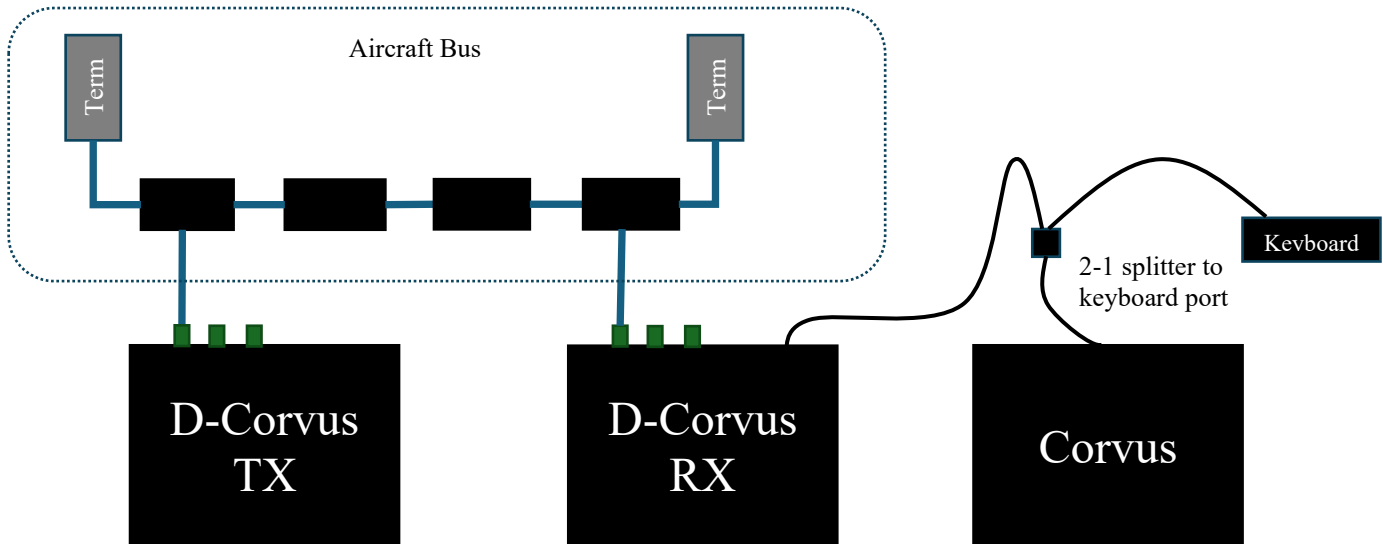

Figure 44 Aircraft Stub Connections

7.3. Aircraft Stub Connection

It is often difficult to access the end of the bus stub at the remote terminal (RT). Most RT stub connections are on the rear of the unit requiring removal of the unit to gain access. Remote Terminals have a variety of connector types and pinouts. Adapting the stub connections to a common connector may require multiple adapter cables. One alternate method of connecting to the Stub end is by using pin adapter cables assemblies provided with the CORVUS unit. These pin adapter assemblies can be connected to the 1553 Triaxial connection on the TX unit and RX unit. The pin adapter end can then be connected to the proper pins on the stub connector.

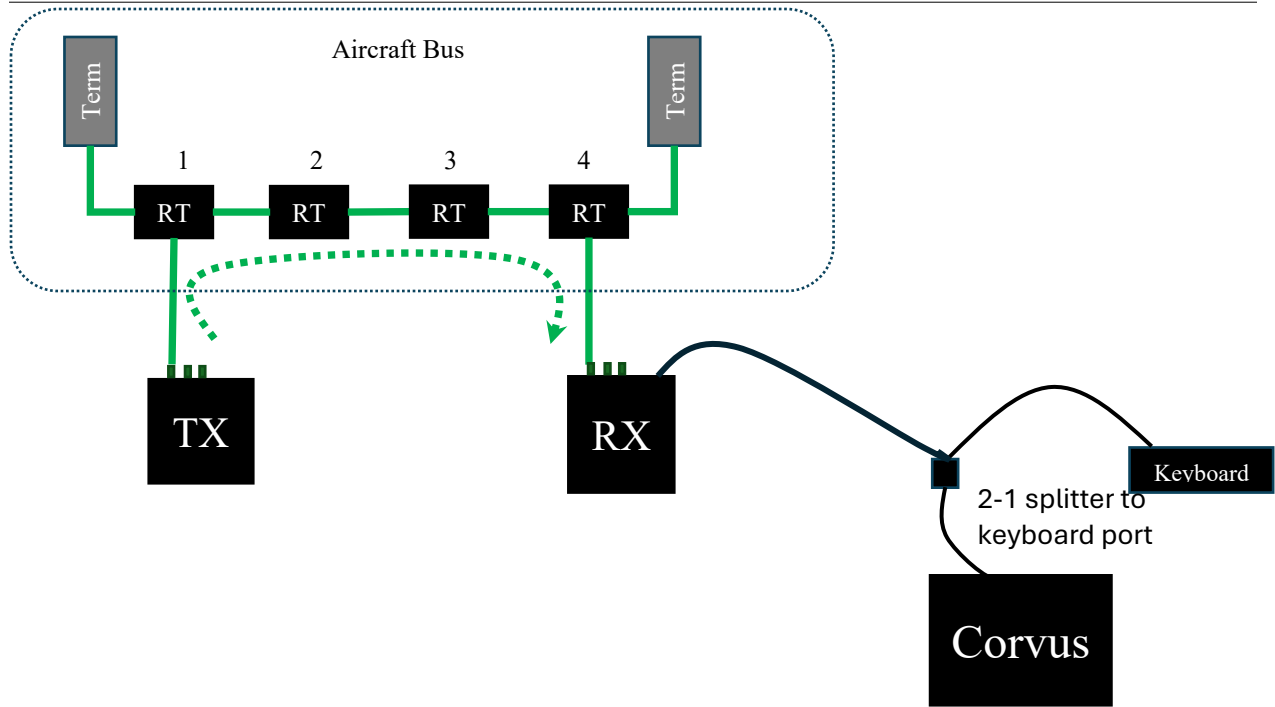

Figure 45 Insertion Loss

Insertion loss is measured for the RT1, RT4 and main bus connections in between as well as terminator connections. Typical Insertion loss is 12dB.

7.4. Calibration

The D-CORVUS system requires calibrated before use if insertion loss measurements are to be made. The following procedure calibrates out the lead cables to zero the RX unit for accurate insertion loss measurements. This must be done before an insertion loss measurement is enabled on in the D-CORVUS application.

1. **Connect** the TX unit to the RX unit as shown in Figure 4. Using the lead cable assemblies provided for connection to the aircraft.

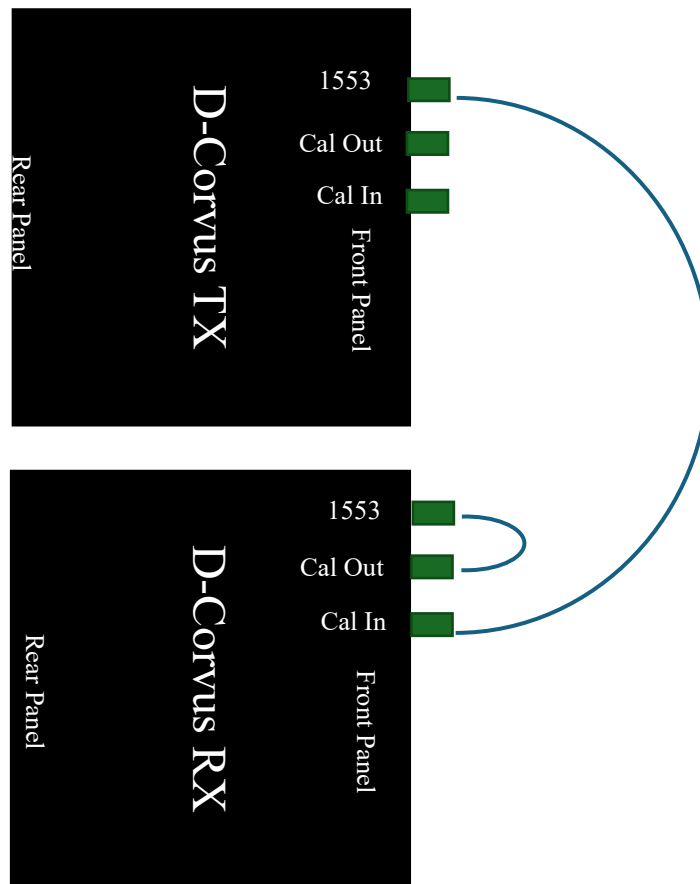

Figure 46 D-CORVUS Calibration Connections

2. **Connect** the RX unit USB port on the rear panel of the RX unit to the CORVUS-400 unit Keyboard port. The D-CORVUS software can be operated with the built in touch screen however some functions may be easier with the keyboard and mouse. To use the keyboard, use the supplied 1-2 USB Splitter cable to connect both the RX unit and the keyboard to the CORVUS-400 keyboard port.



Figure 47 USB Splitter

3. **Apply** Power to the CORVUS unit. The CORVUS must either be powered from its power supply or 28 VDC battery.
4. **Apply** power to the D-CORVUS TX unit by switching the power switch to the on position. The Power LED should illuminate.
5. **Apply** power to the RX unit by switching the power switch to the on position. The power LED should illuminate.
6. When the CORVUS has completed its boot cycle the CORVUS main menu is displayed. select the D-CORVUS application icon.

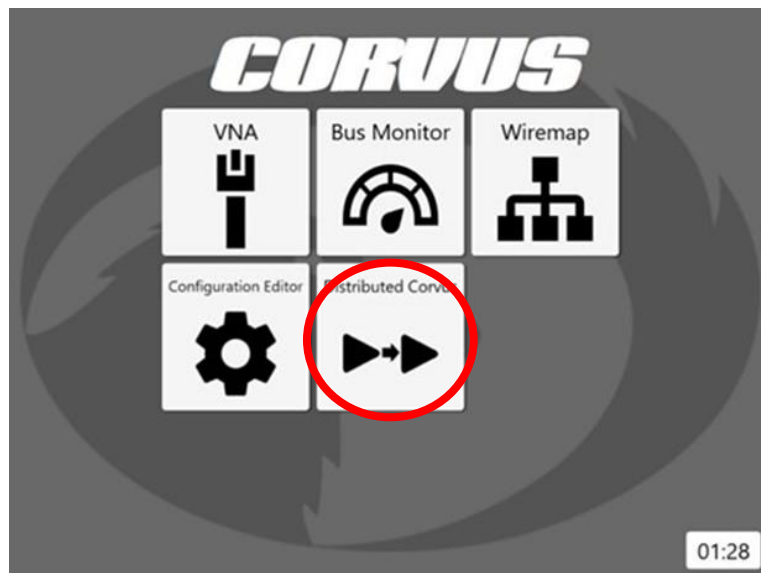

Figure 48 D-CORVUS Icon

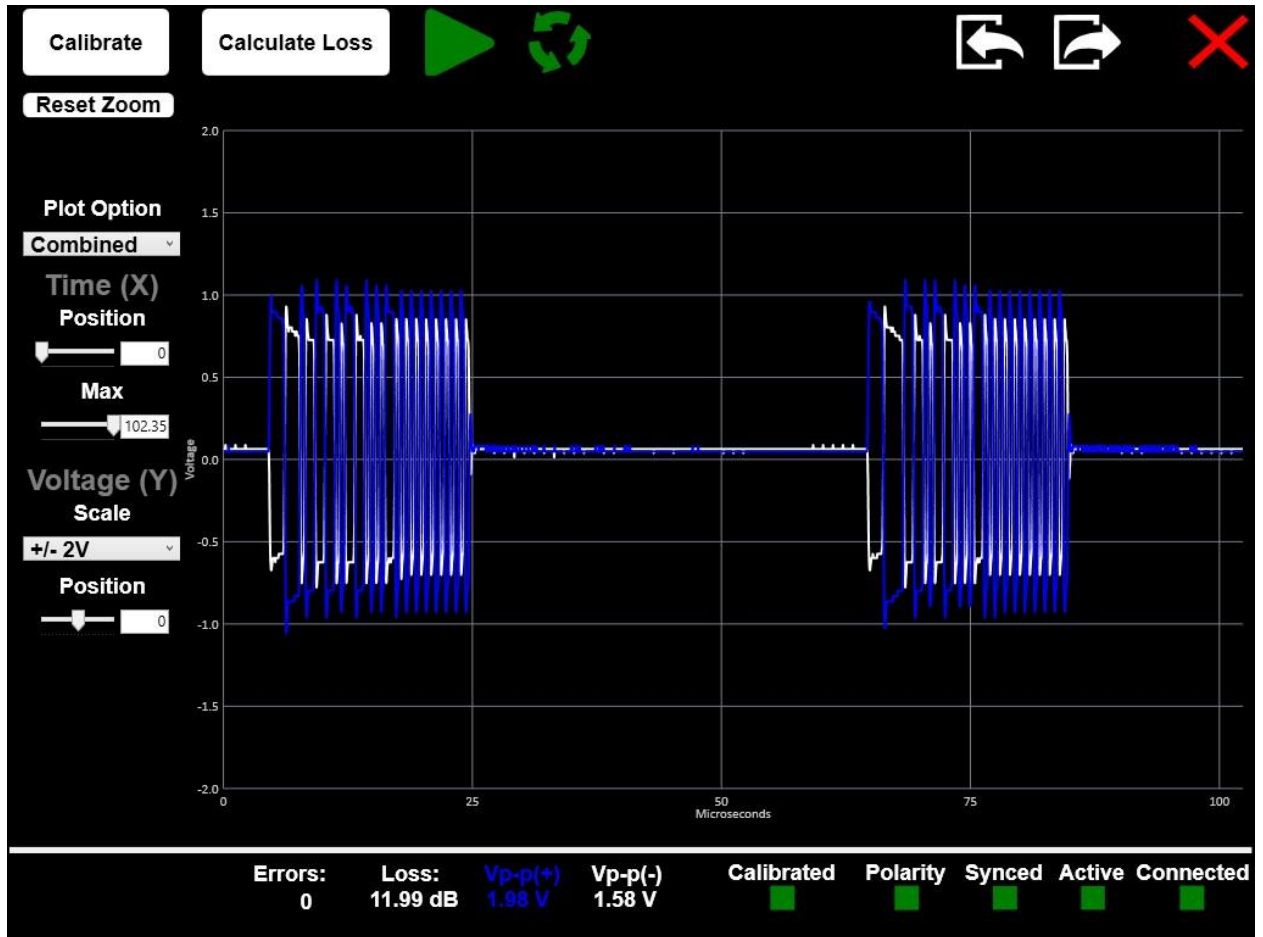

Figure 49 D-CORVUS Application User Interface

7. **Select** the calibration button as shown. The D-CORVUS system calibrates out the test cables and is ready to make insertion loss measurements. The user interface will indicate Calibrated when complete. If calibration fails, some possible causes are loose lead cable connection and/ or failed lead cable. Check connections and retry.
8. The D-CORVUS is now ready for bus testing. Disconnect the lead cables from the RX unit calibration connectors and connect to the bus stubs desired for test.

Note: If power to the RX unit or the CORVUS is lost the calibration procedure must be performed once again. User interface will indicate “Not Calibrated” in red and insertion loss measurement is disabled.

7.5. Aircraft Test Setup

When calibration is complete the D-CORVUS is now ready to test various stub and bus segments. The D-CORVUS lead cables should be connected to the Stub via cable adapters or the Pin adapter cables connected to the stub ends.

7.6. D-CORVUS Operation

The D-CORVUS TX unit is designed to operate without any user interface or control. The unit begins transmitting its data pattern when the power is turned on. The D-CORVUS RX unit must be controlled by the D-CORVUS application. This application is installed on the CORVUS-400 splash screen. The CORVUS RX is connected to the CORVUS mainframe through the keyboard port via 2-1 USB splitter/hub.

7.7. D-CORVUS User Interface

After completing the calibration procedure steps from **Error! Reference source not found.** and connecting the D-CORVUS RX and TX unit to the Cable adapters or pin adapters the D-CORVUS application is ready for test. There are three plot options Combined, Split, and Differential

Combined- Overlays Positive and Negative traces

Split-Splits Positive and Negatives traces

Differential- Positive minus Negative trace

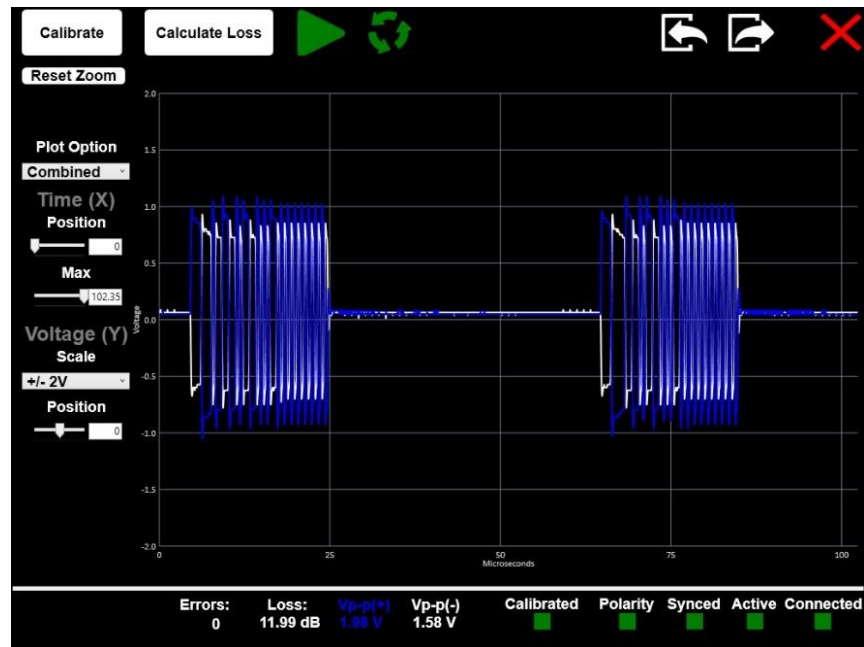

Figure 50 D-CORVUS Plot options Combined

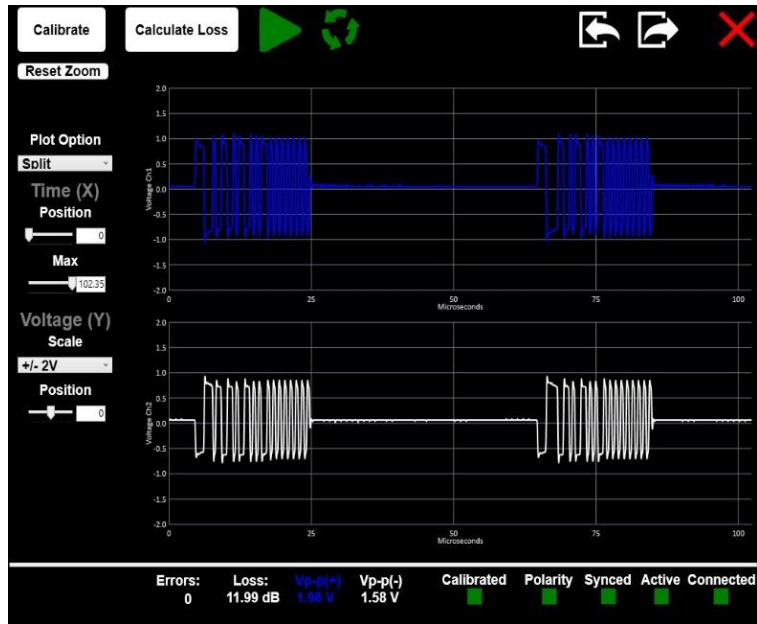

Figure 51 D-CORVUS Plot options Split

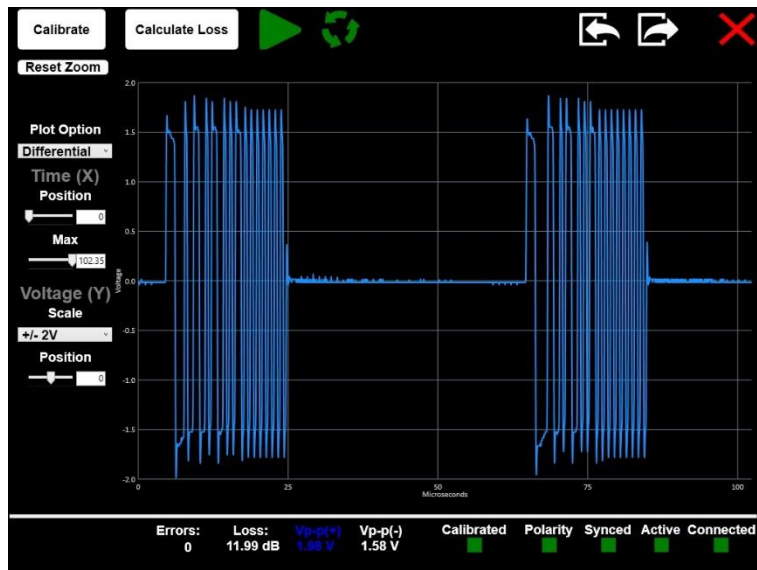

Figure 52 D-CORVUS Plot options Differential





The bottom of the user interface displays D-CORVUS status indications as follows.

Indicator	Description
Error Count	When running continuously and receiving data is synced, the receive unit constantly checks for errors in the data pattern. On a good bus no errors should occur. Any error count greater than 0 indicates poor bus health. If during the collection or error the system loses sync the errors will zero out but will be added to the accumulated error count.
Loss	Indicates the signal loss of the TX unit pattern data going through two couplers, bus segment and stubs. Typical loss is 12dB. This includes bus terminators. A missing bus terminator reduces the signal loss to approximately 9dB indicating a fault. A bad connection or coupler could increase the loss losses greater that 13-14 dB depending on bus under test.
Calibrated	Green Calibrated or Red Not Calibrated If calibrated the Lead cables and D-CORVUS units have been normalized to Zero out internal and lead cable loses and is ready to measure insertion lose.
Polarity	Green Polarity Good or Red polarity Swapped If the polarity is swapped the receive unit will never sync. This indicates somewhere in the segment under test the positive and negative data pair has been miss wired or swapped. *When Connected to a live bus disregard this indicator*
Synced	Green Synced or Red Not Synced Synced indicated we are receiving data good enough for the receive unit to sync up to it and start checking for bit errors. If the indicator shows Not Synced, then the data is corrupted to a point we cannot sync to it. *When Connected to a live bus disregard this indicator*
Active	Green Active or Red No Activity Activity when green shows we are seeing some data transitions. No open connections in bus segment under test. If we have no activity, then we have no data received. This needs to be fixed before we can determine error count or sync receive unit.
Connected	Green Connected or Red Disconnected

Connected indicates the CORVUS unit is able to communicate with the Rx unit. If the status indicates disconnected check the y adapter and USB cable from the Rx unit to the CORVUS. They must be connected for any test to be performed.

On the top of the user interface are the following control buttons



Indicator	Description
Calibrate	The Calibrate function is used to calibrate out lead cables assemblies.
Calculate Loss	After calibration and connection to the bus under test the Calculate loss function measures signal loss from stub to stub.
Collect single	Collect and display 1553 data single trace trigger.
	
Collect Data Continuous	Collect and display 1553 data with continuous trace trigger.
	
Import File	Import captured and saved 1553 data trace.
	
Export File	Save a 1553 data trace to file.
	

 Front Panel Indicators

D-CORVUS has four LED indicators for Power and battery status.

Indicator	Description
Power	Green LED to indicate that the unit is powered on.
Battery Low	Green LED that will blink on and off when the Battery is low on charge. When the light is illuminated there is about 10 minutes of run time before the unit will power off.
Charge	Green LED illuminates when the 5V supply is connected to the +5VDC port. <ul style="list-style-type: none"> • To charge the unit the On/Off switch must be in the on position and not be connected to a live bus. • Connect the 5V Power Adapter to the +5VDC port. • A flashing Green LED indicates battery is charging. • A solid Green LED indicates the battery is fully charged and ready to use.
Fault	A solid Red LED indicates there is a battery charging fault. If this Led illuminates, then cycle power by flipping the On/Off switch. If the LED is still illuminated after a power cycle, then contact DragoonITCN Customer Service for support.

7.8. Battery Information

D-CORVUS uses a readily available rechargeable lithium-ion battery pack. Secondary/replacement battery packs can be made available by contacting DragoonITCN Customer Service.

Description	Rechargeable Battery
Battery Chemistry	Lithium-Ion
Voltage - Rated	3.7V
Capacity	6.27Ah
Standard Run Time	4 Hrs.
Standard Charge Time	8 Hrs.
Cycle Life	Cycle life \geq 500



CHAPTER 8 VEGAS Diode

8. Vegas Diode

8.1. Vegas Diode Overview

DragoonITCN's Vegas Data Diode is a non-ruggedized module that addresses concerns regarding use of untrusted, commercial-off-the-shelf (COTS) bus logging on aircraft with a MIL-STD-1553 bus interface. VEGAS is inserted between the active bus and CORVUS to ensure that it is only capable of receiving bus traffic. In this scenario, the aircraft's interface bus would be isolated and CORVUS would only be able to receive bus traffic.

8.2. Vegas Diode Operation

To apply the Vegas Diode, connect Vegas Diode to the 5 VDC output on CORVUS top connector panel, connect the aircraft bus under test to both of the IN ports on Vegas. CORVUS is then connected to the OUT ports.

Note: Make sure both the primary and secondary busses match on the Vegas for the aircraft side and CORVUS side (Primary on 1 and Secondary on 2)

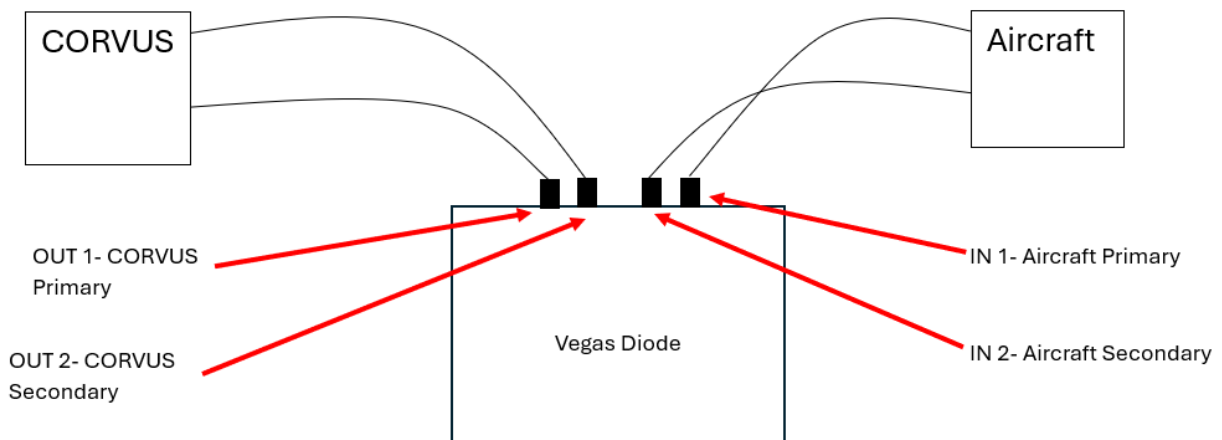

Figure 53 Vegas Connections

8.3. Benefits

- Protects the avionics bus from untrusted, commercial off-the-shelf (COTS) bus monitors
- Protects the avionics bus from traffic insertion at open test ports on aircraft
- Protects the avionics bus from roll-on / -off equipment
- Acts as a repeater to extend the length of the avionics bus

8.4. Specifications

Hardware has been subjected to the following tests:

- Vibration
- Shock
- Temp
- Humidity
- Altitude (MIL-STD-810G)
- Power (MIL-STD-704F)
- Conductive Emissions (MIL-STD-461)



Size	4.5" L x 4.7" W x 1.4" H
Weight	14 oz
Power	5 VDC 0.5Amps

CHAPTER 9 TROUBLESHOOTING / SERVICE

9. TROUBLESHOOTING/SERVICE

9.1. FAQ

DragoonITCN is committed to providing superior, tailored service and troubleshooting assistance to our customers.

- 1. What if CORVUS fails to boot up?**
Ensure the +28VDC is applied from the AC adapter or battery pack and power connector is properly engaged.
- 2. What if my screen is completely black but there is a faint outline of the main screen?**
Reboot the machine. If the issue persists, contact DragoonITCN.
- 3. What if the bus monitor landing screen has a red connection icon?**
Restart CORVUS. If the issue persists, contact DragoonITCN.

9.2. Contact Information

In case of issues that are not addressed in this manual, please call Tim Myers at DragoonITCN at 937 439 9223 x 211. Email at tmyers@dragoonitcn.com

9.3. Software Updates

DragoonITCN has generated applications for the User to upgrade the SW on CORVUS as part of PMEL while maintaining cyber security (i.e. no direct connection to Internet).

Using the SD card, periodic SW updates will be performed as spiral upgrades and OS patches are implemented.

It is not recommended that the user open the CORVUS case for repairs.



CHAPTER 10 DragoonITCN WARRANTY

10. DragoonITCN WARRANTY

10.1. LIMITED WARRANTY

Policy

DragoonITCN warrants that all hardware and software products will be free from defects in materials and workmanship for a period of One Year from the date of delivery to the customer.

In the event that a defect is discovered during the warranty period, DragoonITCN will, at its option, repair or replace the defective hardware and/or software items at no charge on a pre-paid, return to factory basis. DragoonITCN retains the right to effect repairs with new or used component parts. Repaired or replaced items will carry a One Year warranty or the balance of factory warranty, whichever is longer.

Products supplied by DragoonITCN are for the purpose described in published sales literature and official DragoonITCN documentation. Any use of the product in a manner other than that described is not covered by the warranty. Damage caused by, but not limited to accident, abuse, misapplication, service performed by non DragoonITCN personnel, third party hardware or software, acts of God, power over-voltages or failures, and unauthorized installation where applicable, are not covered by warranty.

Warranty Procedure

Any product failure or defect should be reported to DragoonITCN customer support personnel immediately by calling 800-439-4039. An attempt will be made to diagnose and correct the problem remotely. If remote resolution of a problem is unsuccessful, the product must be returned prepaid to DragoonITCN for repair or replacement. A return authorization (RA) is required for all returned goods. A DragoonITCN customer service support person will issue an RA number when a return to factory determination is made. Time and expenses for on-site problem diagnosis and repair are not covered by the warranty.

Scope of Agreement

This Warranty is in lieu of all other warranties, expressed, implied or statutory, including without limitation those of merchantability and fitness for a particular purpose. DragoonITCN shall not be liable for actual, exemplary, indirect or consequential damages including loss of goodwill and profits suffered by the purchaser and/or end user resulting from the non-delivery, use or inability to use the products. There are not express or implied warranties arising from course of dealing, course of performance or usage of trade, which extend beyond the face of this limited warranty. DragoonITCN neither assumes nor authorizes any person or entity to assume for it any other liability in connection with the sale of its products. DragoonITCN has no responsibility whatsoever for reimbursing purchaser or purchaser's customer or end users, not shall DragoonITCN be liable for damages for repair or replacement costs incurred by purchaser or its customers or end users in connection with DragoonITCN's products without DragoonITCN giving its written authorization. No liability to DragoonITCN shall arise out of DragoonITCN rendering technical assistance or support in connection with any purchaser's order.



10.2. DragoonITCN CUSTOMER SUPPORT

Policy

The DragoonITCN Customer Support Program provides phone and email support for customers having problems with the system hardware or software. Problems may be operation, configuration, or set-up/installation issues. Not covered through Customer Support are engineering services, such as changes to hardware or software, or BCIT application specific services such as configuring user's equipment for tests.

Procedure

When a user requires Customer Technical Support, DragoonITCN will follow the procedures below:

1. Phone consultation between the user and DragoonITCN's technical staff. This may involve submission of computer files, listings or scope traces to DragoonITCN for analysis. DragoonITCN will generate a Customer Trouble Report (CTR) to track the inquiry.
2. Email inquiries may be submitted to tmyers@dragoonitcn.com. DragoonITCN Customer Support will reply to the email during normal working hours and include the Customer Trouble Report number.

DragoonITCN Contact Information:

Tim Myers
PH: 800-439-4039
Email: tmyers@dragoonitcn.com
Fax: 937-439-9173
Address: 900 Senate Dr., Dayton, OH 45459



10.3. EXTENDED WARRANTY

Policy

The DragoonITCN Extended Warranty program includes the DragoonITCN Customer Support Program.

The Extended Warranty Program provides the user coverage against all hardware components and software failures for the life of the warranty.

When the Extended Warranty is purchased prior to the expiration of the product's initial limited warranty, the coverage will take effect upon the expiration of the limited warranty. If the Extended Warranty is purchased after the limited warranty has lapsed, an inspection and test of the product will be required to verify that it is fully operational. This inspection fee and any repair cost required to return the unit to operational status are not covered under the Extended Warranty and will be the responsibility of the user. Also, any upgrade cost required to convert the unit to DragoonITCN's current standard hardware configuration is not covered under the Extended Warranty.

Procedure

When the user determines that a product's system capability is not functioning as specified, DragoonITCN will follow the procedures below to correct the problem:

1. Phone consultation between the user and DragoonITCN's technical staff to identify the cause of the anomaly. This may involve submission of computer files, listings or scope traces to DragoonITCN for analysis.
2. For problems identified as a failed hardware component, the user will be advised to return the unit, freight prepaid, to DragoonITCN for repair. DragoonITCN will return the repaired unit to the user freight collect. If the unit cannot be returned to DragoonITCN for repair, DragoonITCN has technicians available to come to your location. Travel time and expenses are not covered under the Extended Warranty and are the responsibility of the user. Upon request, DragoonITCN can provide a written quotation for an on-site visit. Travel time and expenses will be invoiced separately.
3. For anomalies associated with hardware and/or software, DragoonITCN will notify the customer of our plan to correct the condition and the scheduled time frame of the correction. This service is supplied to the user free of charge. If hardware or firmware modifications are required to correct the anomaly, they will also be provided to the user at no charge.

DragoonITCN Contact Information: PH: 800-439-4039
Email: tmyers@dragoonitcn.com
Fax: 937-439-9173
Address: 900 Senate Dr., Dayton, OH 45459



11. GLOSSARY OF TERMS

11.1. TERMS

CORVUS - is an integrated test tool designed to enable complete cable integrity testing along with MIL-STD-1553B bus monitoring.

Bus Monitor - This application processes statistics about MIL-STD-1553 busses and displays it in a simple and easy to understand GUI format.

MIL-STD-1553B - is a military standard defining the characteristics of a serial data bus to be used for avionics. MIL-STD-1553B uses a differential, bi-phase Manchester encoded signal to reliably transmit data without a clock signal and supports up to 31 Remote Terminals and a Bus Controller.

Terminator - Resistive electronic component designed to be connected on either end of a data bus, to minimize signal reflection.

Vector Network Analyzer (VNA) – Used to measure insertion loss and return loss of cables and antennas.

RT – Remote Terminal

DUT- Device Under Test